

DATA SHEET

2N5484; 2N5485; 2N5486 N-channel field-effect transistors

Product specification
File under Discrete Semiconductors, SC07

December 1997

N-channel field-effect transistors

2N5484; 2N5485; 2N5486

FEATURES

- Low noise
- Interchangeability of drain and source connections
- High gain.

DESCRIPTION

N-channel, symmetrical, silicon junction FETs in a SOT54 (TO-92) envelope, intended for use in VHF/UHF amplifiers, oscillators and mixers.

PINNING - SOT54 (TO-92)

PIN	DESCRIPTION
1	gate
2	source
3	drain

QUICK REFERENCE DATA

SYMBOL	PARAMETER	CONDITIONS	MIN.	MAX.	UNIT
V_{DS}	drain-source voltage		–	25	V
I_{DSS}	drain current	$V_{DS} = 15\text{ V}; V_{GS} = 0$			
	2N5484		1	5	mA
	2N5485		4	10	mA
	2N5486		8	20	mA
P_{tot}	total power dissipation	up to $T_{amb} = 25\text{ °C}$	–	400	mW
$V_{GS(off)}$	gate-source cut-off voltage	$V_{DS} = 15\text{ V}; I_D = 1\text{ nA}$			
	2N5484		–0.3	–3	V
	2N5485		–0.5	–4	V
	2N5486		–2	–6	V
$ Y_{fs} $	common source transfer admittance	$V_{DS} = 15\text{ V}; V_{GS} = 0;$ $f = 1\text{ kHz}$			
	2N5484		3	6	mS
	2N5485		3.5	7	mS
	2N5486		4	8	mS

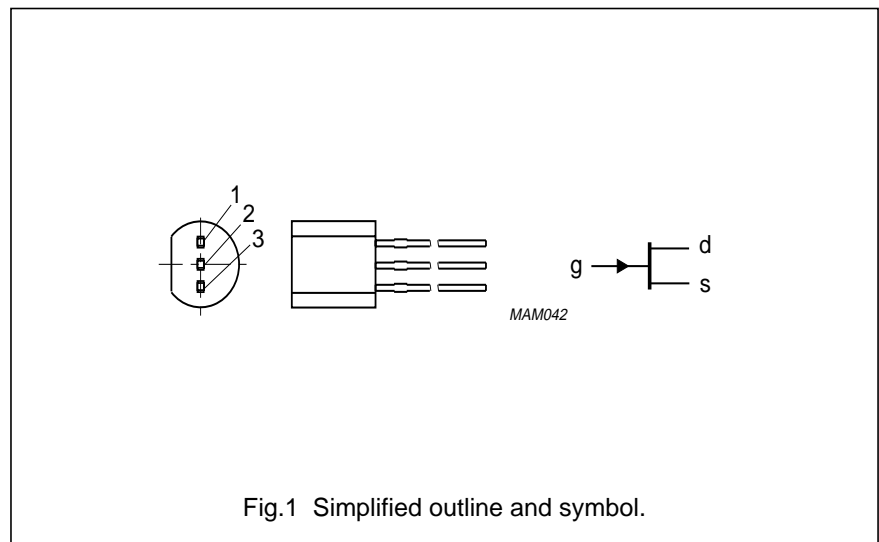

N-channel field-effect transistors

2N5484; 2N5485; 2N5486

LIMITING VALUES

In accordance with the Absolute Maximum Rating System (IEC 134).

SYMBOL	PARAMETER	CONDITIONS	MIN.	MAX.	UNIT
V_{DS}	drain-source voltage		–	25	V
V_{GSO}	gate-source voltage		–	–25	V
V_{GDO}	gate-drain voltage		–	–25	V
I_G	DC forward gate current		–	10	mA
P_{tot}	total power dissipation	up to $T_{amb} = 25\text{ °C}$ (note 1)	–	400	mW
T_{stg}	storage temperature		–65	+150	°C
T_j	junction temperature		–	150	°C

THERMAL RESISTANCE

SYMBOL	PARAMETER	THERMAL RESISTANCE
$R_{th\ j-a}$	from junction to ambient (note 1)	350 K/W

Note

1. Device mounted on a printed circuit board; maximum lead length 3 mm; mounting pad for drain lead minimum 10 mm × 10 mm.

STATIC CHARACTERISTICS $T_j = 25\text{ °C}$ unless otherwise specified.

SYMBOL	PARAMETER	CONDITIONS	MIN.	MAX.	UNIT
$V_{(BR)GSS}$	gate-source breakdown voltage	$V_{DS} = 0$; $I_G = -1\ \mu\text{A}$	–25	–	V
I_{DSS}	drain current 2N5484 2N5485 2N5486	$V_{DS} = 15\text{ V}$; $V_{GS} = 0$	1 4 8	5 10 20	mA mA mA
I_{GSS}	reverse gate leakage current	$V_{DS} = 0$; $V_{GS} = -15\text{ V}$	–	–1	nA
V_{GSS}	gate-source forward voltage	$V_{DS} = 0$; $I_G = 1\text{ mA}$	–	1	V
$V_{GS(off)}$	gate-source cut-off voltage 2N5484 2N5485 2N5486	$V_{DS} = 15\text{ V}$; $I_D = 1\text{ nA}$	–0.3 –0.5 –2	–3 –4 –6	V V V
$ Y_{fs} $	common source transfer admittance 2N5484 2N5485 2N5486	$V_{DS} = 15\text{ V}$; $V_{GS} = 0$	3 3.5 4	6 7 8	mS mS mS
$ Y_{os} $	common source output admittance 2N5484 2N5485 2N5486	$V_{DS} = 15\text{ V}$; $V_{GS} = 0$	– – –	50 60 75	μS μS μS

N-channel field-effect transistors

2N5484; 2N5485; 2N5486

DYNAMIC CHARACTERISTICS

$T_j = 25\text{ }^\circ\text{C}$; $V_{DS} = 15\text{ V}$; $V_{GS} = 0$

SYMBOL	PARAMETER	CONDITIONS	MIN.	TYP.	MAX.	UNIT
C_{is}	input capacitance	$f = 1\text{ MHz}$	–	–	5	pF
C_{os}	output capacitance	$f = 1\text{ MHz}$	–	–	2	pF
C_{rs}	feedback capacitance	$f = 1\text{ MHz}$	–	–	1	pF
g_{is}	common source input conductance					
	2N5484	$f = 100\text{ MHz}$	100	–	–	μS
	2N5485; 2N5486	$f = 400\text{ MHz}$	–	–	1	mS
g_{fs}	common source transfer conductance					
	2N5484	$f = 100\text{ MHz}$	2.5	–	–	mS
	2N5485	$f = 400\text{ MHz}$	3	–	1	mS
	2N5486	$f = 400\text{ MHz}$	3.5	–	1	mS
g_{os}	common source output conductance					
	2N5484	$f = 100\text{ MHz}$	–	–	75	μS
	2N5485; 2N5486	$f = 400\text{ MHz}$	–	–	100	μS
V_n	equivalent input noise voltage	$f = 100\text{ Hz}$	–	5	–	nV/ $\sqrt{\text{Hz}}$

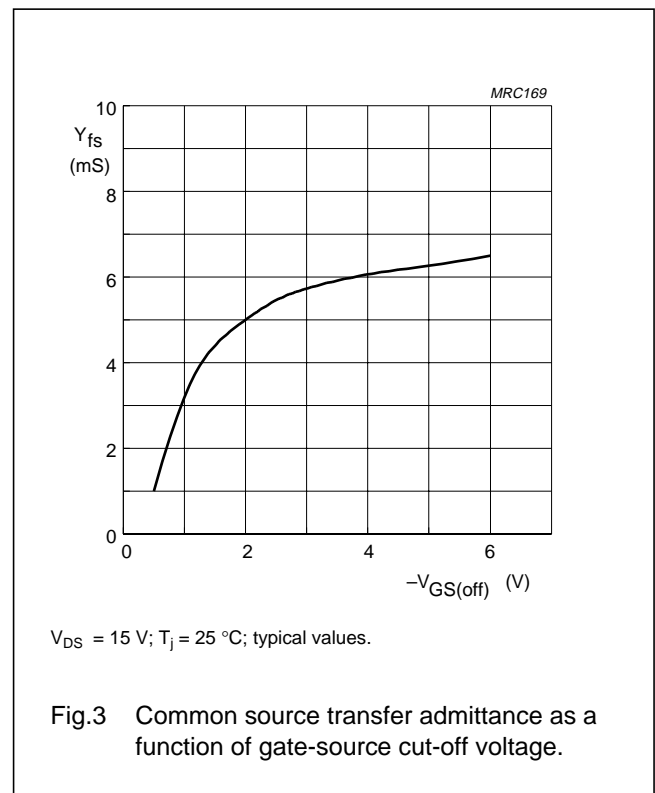
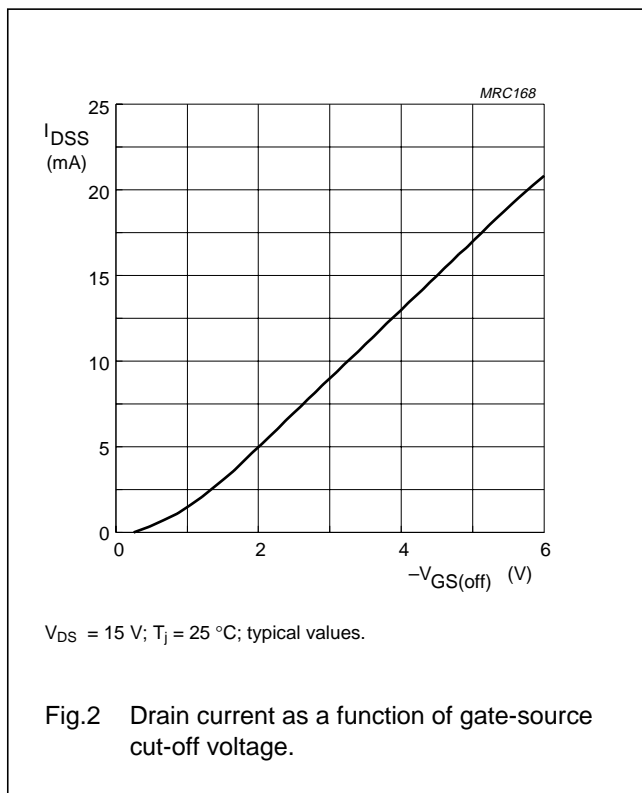

N-channel field-effect transistors

2N5484; 2N5485; 2N5486

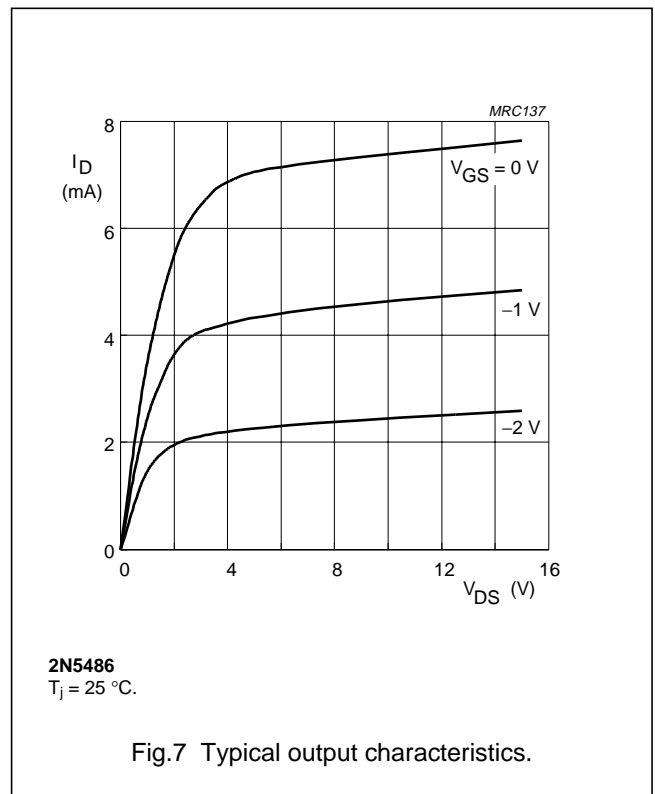
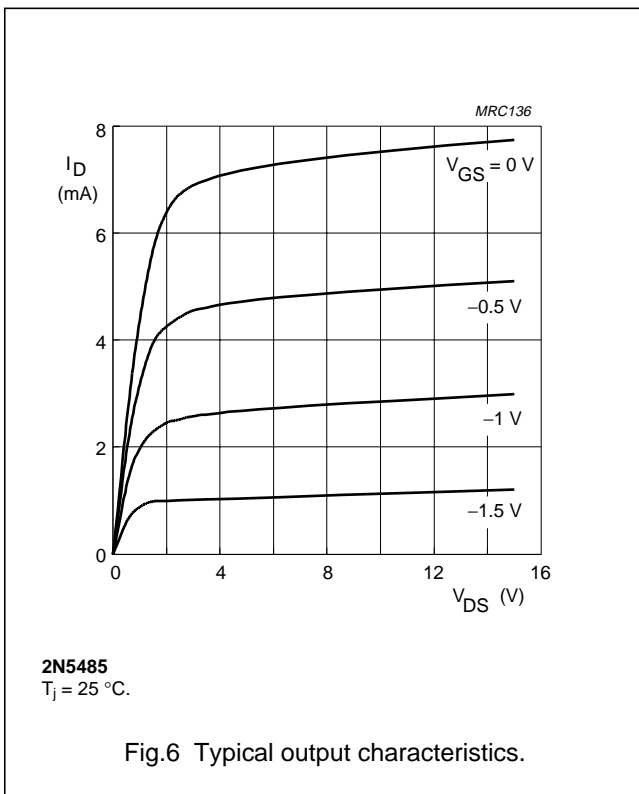
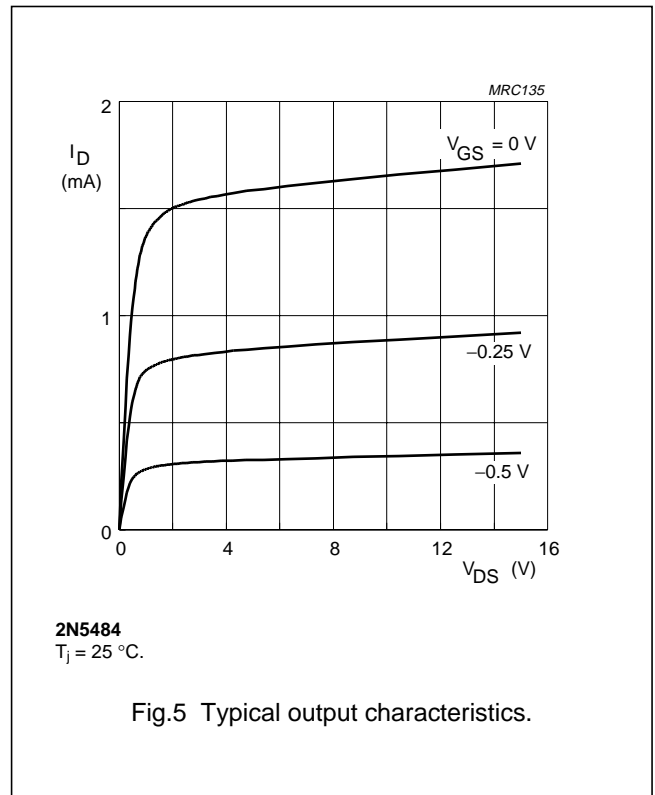
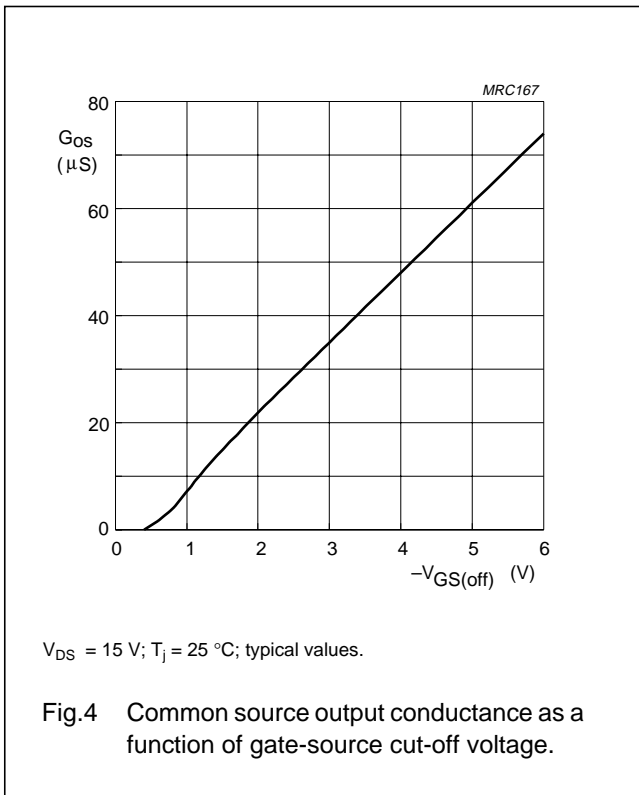

N-channel field-effect transistors

2N5484; 2N5485; 2N5486

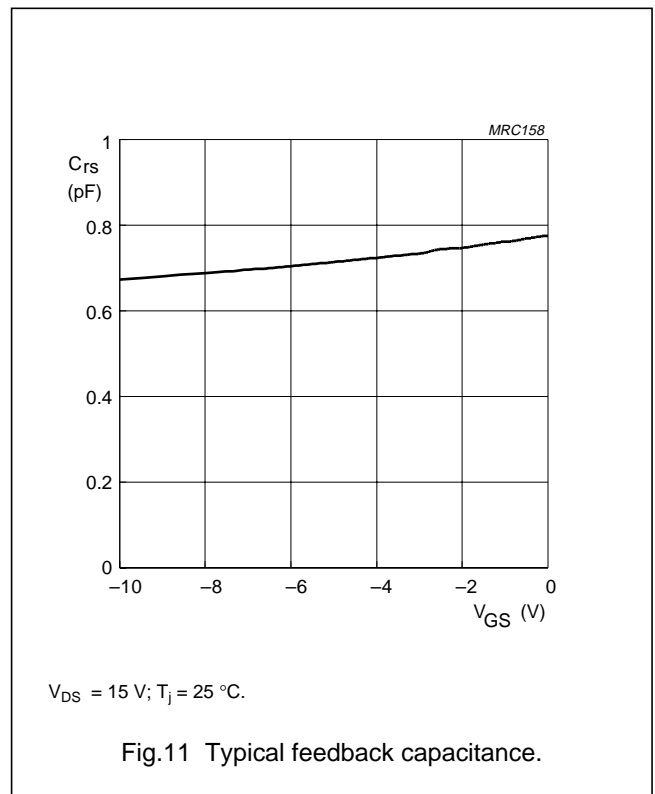
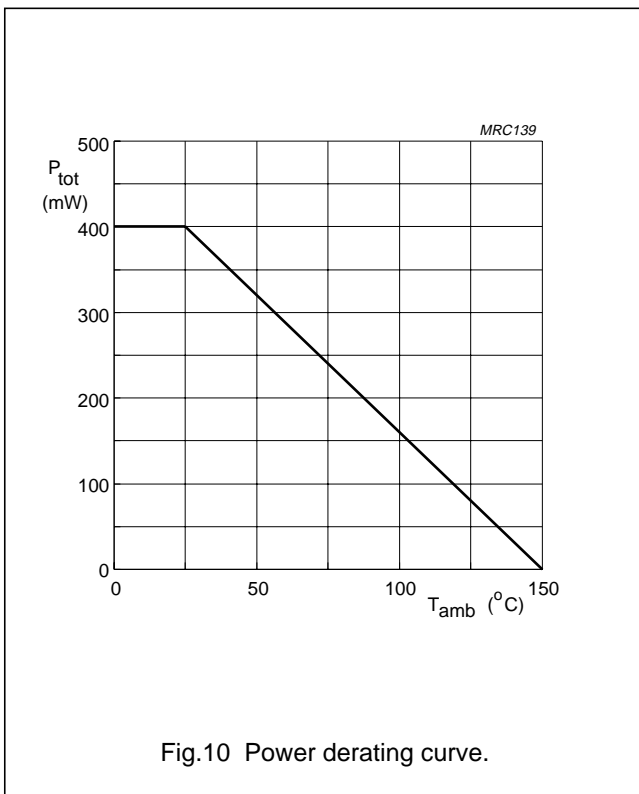
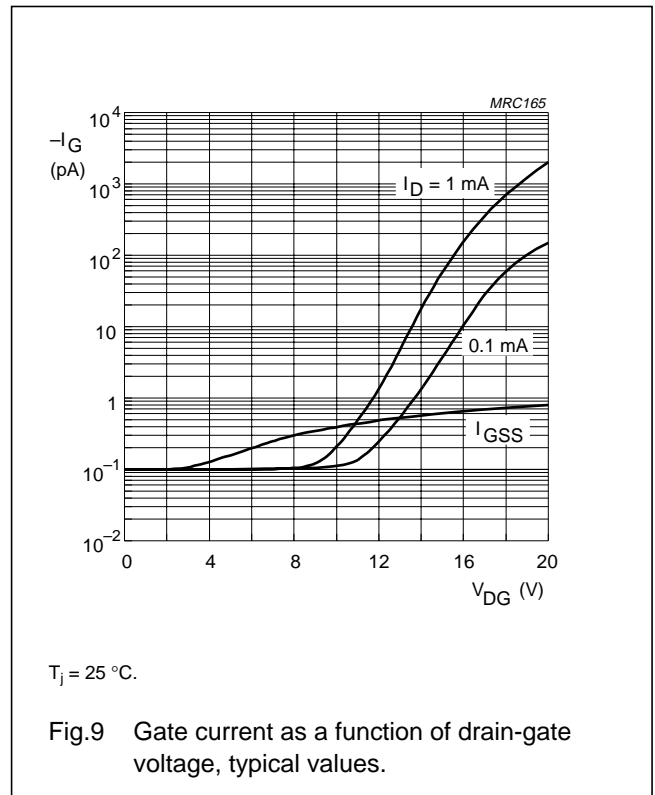
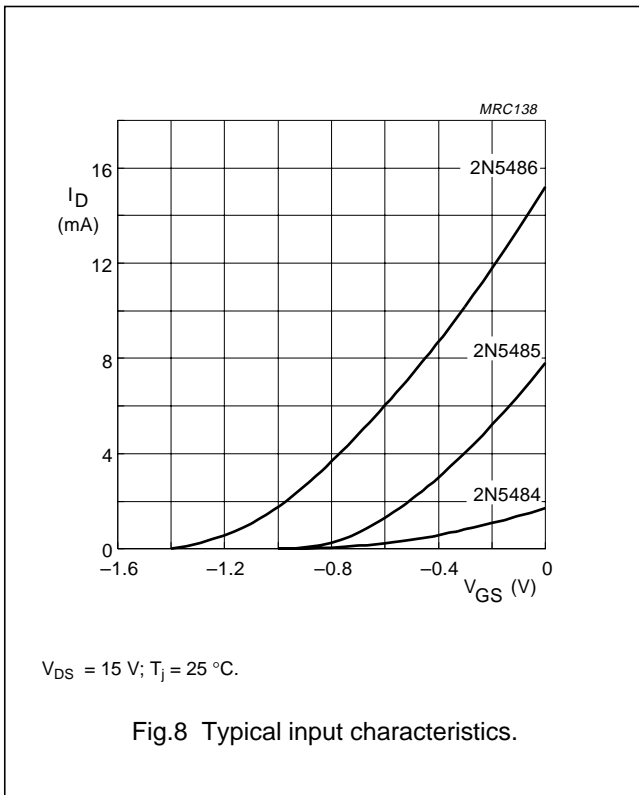

N-channel field-effect transistors

2N5484; 2N5485; 2N5486

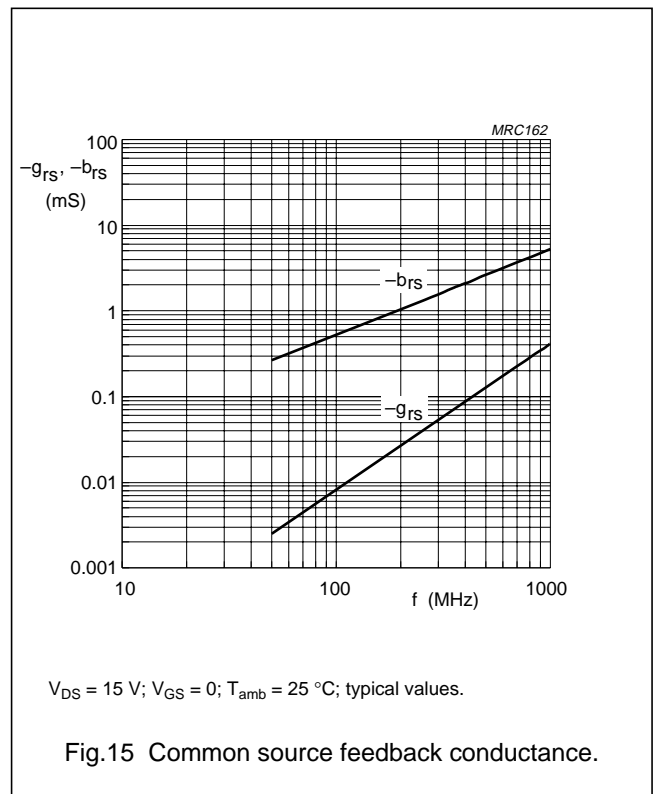
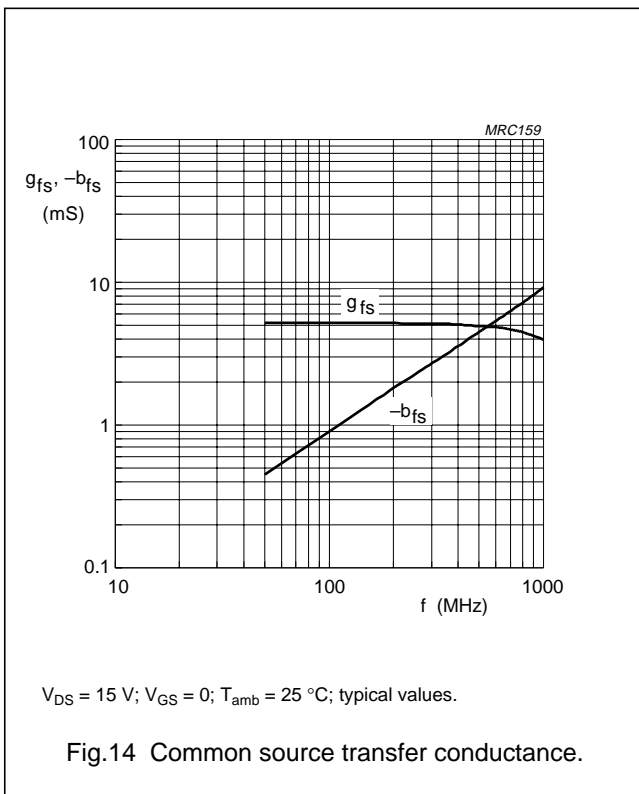
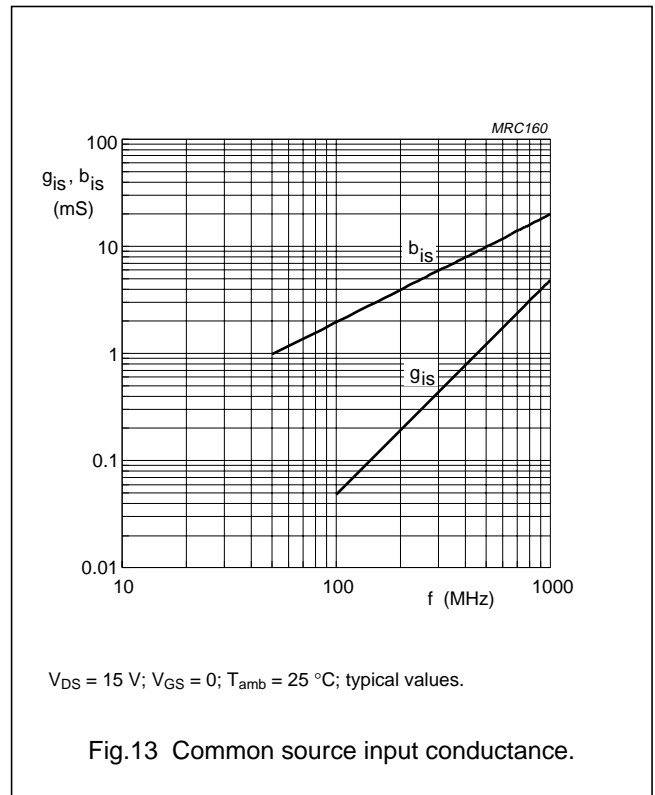
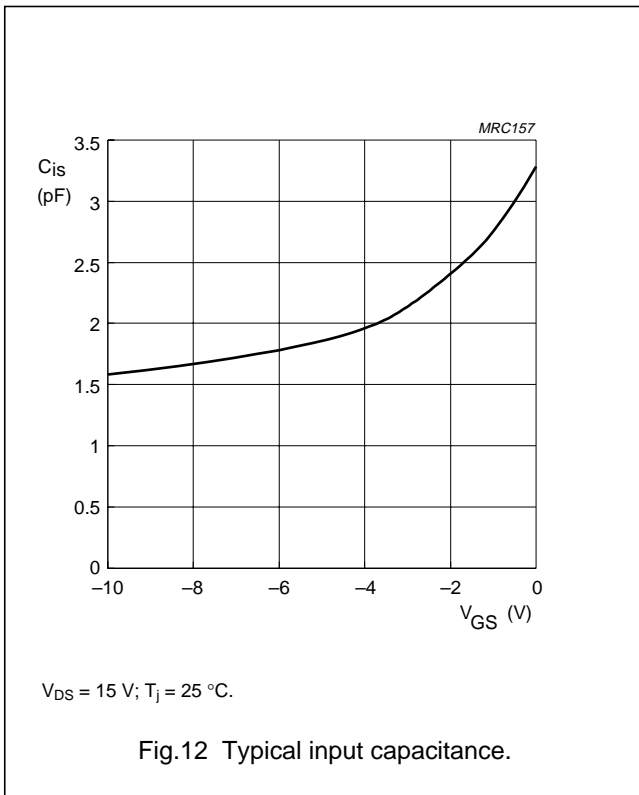

N-channel field-effect transistors

2N5484; 2N5485; 2N5486

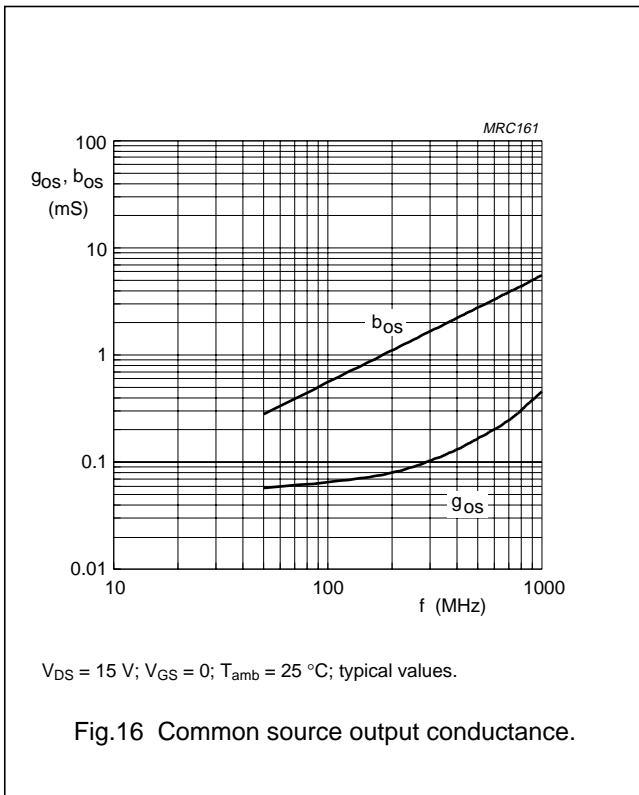

N-channel field-effect transistors

2N5484; 2N5485; 2N5486

PACKAGE OUTLINE

Plastic single-ended leaded (through hole) package; 3 leads

SOT54

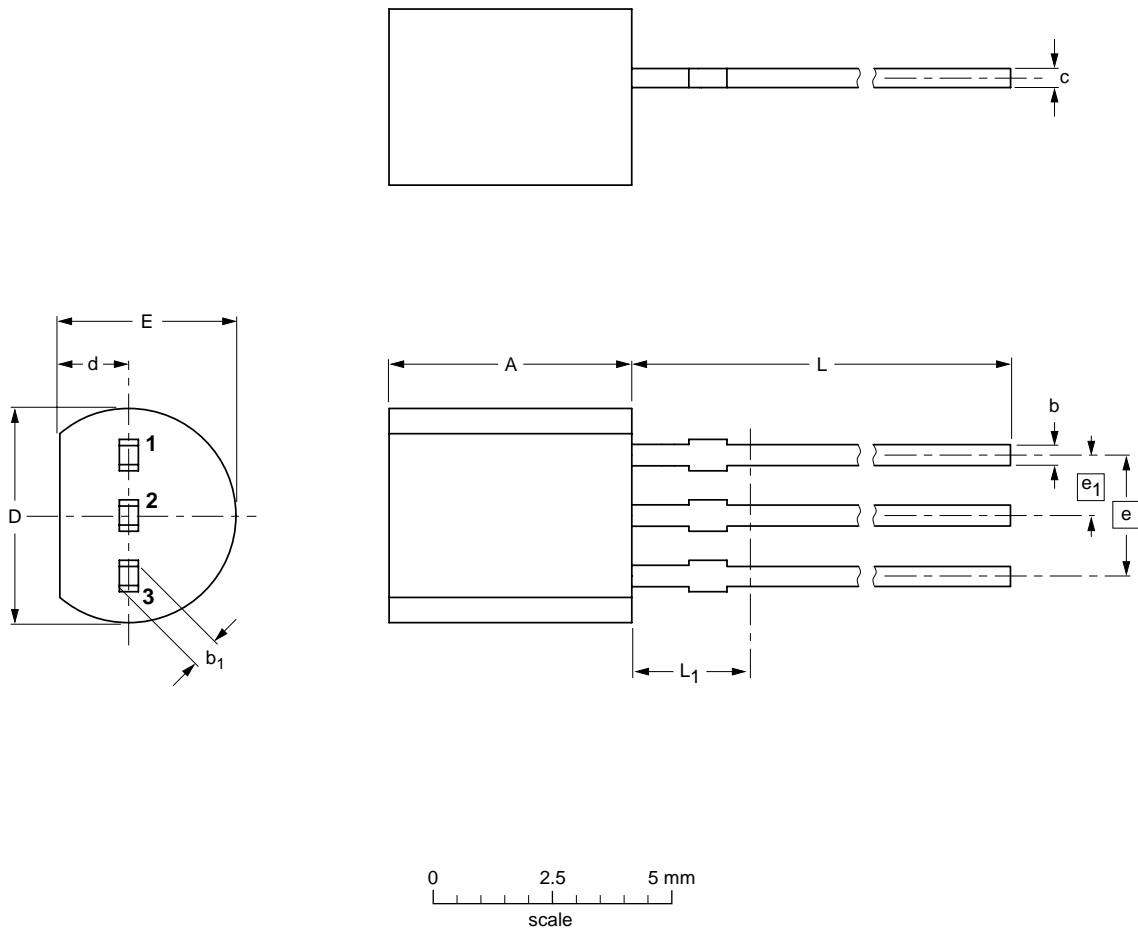

DIMENSIONS (mm are the original dimensions)

UNIT	A	b	b ₁	c	D	d	E	e	e ₁	L	L ₁ ⁽¹⁾
mm	5.2 5.0	0.48 0.40	0.66 0.56	0.45 0.40	4.8 4.4	1.7 1.4	4.2 3.6	2.54	1.27	14.5 12.7	2.5

Note

1. Terminal dimensions within this zone are uncontrolled to allow for flow of plastic and terminal irregularities.

OUTLINE VERSION	REFERENCES			EUROPEAN PROJECTION	ISSUE DATE
	IEC	JEDEC	EIAJ		
SOT54		TO-92	SC-43		97-02-28

N-channel field-effect transistors

2N5484; 2N5485; 2N5486

DEFINITIONS

Data sheet status	
Objective specification	This data sheet contains target or goal specifications for product development.
Preliminary specification	This data sheet contains preliminary data; supplementary data may be published later.
Product specification	This data sheet contains final product specifications.
Short-form specification	The data in this specification is extracted from a full data sheet with the same type number and title. For detailed information see the relevant data sheet or data handbook.
Limiting values	
Limiting values given are in accordance with the Absolute Maximum Rating System (IEC 134). Stress above one or more of the limiting values may cause permanent damage to the device. These are stress ratings only and operation of the device at these or at any other conditions above those given in the Characteristics sections of the specification is not implied. Exposure to limiting values for extended periods may affect device reliability.	
Application information	
Where application information is given, it is advisory and does not form part of the specification.	

LIFE SUPPORT APPLICATIONS

These products are not designed for use in life support appliances, devices, or systems where malfunction of these products can reasonably be expected to result in personal injury. Philips customers using or selling these products for use in such applications do so at their own risk and agree to fully indemnify Philips for any damages resulting from such improper use or sale.