

SIPMOS® Power Transistor

BUZ 10 L

- N channel
- Enhancement mode
- Logic Level
- Avalanche-rated

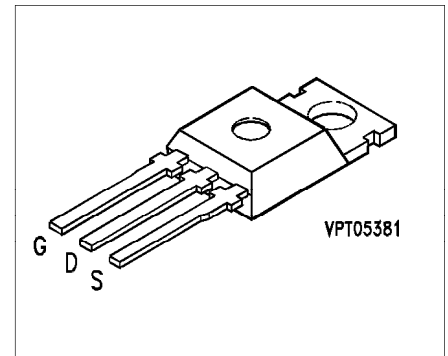

Type	V_{DS}	I_D	$R_{DS(on)}$	Package ¹⁾	Ordering Code
BUZ 10 L	50 V	23 A	0.07 Ω	TO-220 AB	C67078-S1329-A2

Maximum Ratings

Parameter	Symbol	Values	Unit
Continuous drain current, $T_C = 26\text{ }^\circ\text{C}$	I_D	23	A
Pulsed drain current, $T_C = 25\text{ }^\circ\text{C}$	$I_{D\text{ puls}}$	92	
Avalanche current, limited by $T_{j\text{ max}}$	I_{AR}	23	
Avalanche energy, periodic limited by $T_{j\text{ (max)}}$	E_{AR}	1.3	mJ
Avalanche energy, single pulse $I_D = 23\text{ A}$, $V_{DD} = 25\text{ V}$, $R_{GS} = 25\text{ }\Omega$ $L = 15.1\text{ }\mu\text{H}$, $T_j = 25\text{ }^\circ\text{C}$	E_{AS}	8	
Gate-source voltage	V_{GS}	± 10	V
Gate-source peak voltage, aperiodic	V_{gs}	± 20	
Power dissipation, $T_C = 25\text{ }^\circ\text{C}$	P_{tot}	75	W
Operating and storage temperature range	T_j, T_{stg}	- 55 ... + 150	$^\circ\text{C}$
Thermal resistance, chip-case	$R_{th\text{ JC}}$	≤ 1.67	K/W
DIN humidity category, DIN 40 040		E	-
IEC climatic category, DIN IEC 68-1		55/150/56	-

1) See chapter Package Outlines.

Electrical Characteristics

at $T_j = 25\text{ °C}$, unless otherwise specified.

Parameter	Symbol	Values			Unit
		min.	typ.	max.	

Static characteristics

Drain-source breakdown voltage $V_{GS} = 0\text{ V}, I_D = 0.25\text{ mA}$	$V_{(BR)DSS}$	50	–	–	V
Gate threshold voltage $V_{GS} = V_{DS}, I_D = 1\text{ mA}$	$V_{GS(th)}$	1.5	2.0	2.5	
Zero gate voltage drain current $V_{DS} = 50\text{ V}, V_{GS} = 0\text{ V}$ $T_j = 25\text{ °C}$ $T_j = 125\text{ °C}$	I_{DSS}	–	0.1 10	1.0 100	μA
Gate-source leakage current $V_{GS} = 20\text{ V}, V_{DS} = 0\text{ V}$	I_{GSS}	–	10	100	nA
Drain-source on-resistance $V_{GS} = 5\text{ V}, I_D = 11.5\text{ A}$	$R_{DS(on)}$	–	0.06	0.07	Ω

Dynamic characteristics

Forward transconductance $V_{DS} \geq 2 \times I_D \times R_{DS(on)max}, I_D = 11.5\text{ A}$	g_{fs}	8	14.5	–	S
Input capacitance $V_{GS} = 0\text{ V}, V_{DS} = 25\text{ V}, f = 1\text{ MHz}$	C_{iss}	–	800	1100	pF
Output capacitance $V_{GS} = 0\text{ V}, V_{DS} = 25\text{ V}, f = 1\text{ MHz}$	C_{oss}	–	300	450	
Reverse transfer capacitance $V_{GS} = 0\text{ V}, V_{DS} = 25\text{ V}, f = 1\text{ MHz}$	C_{rss}	–	110	170	
Turn-on time t_{on} , ($t_{on} = t_{d(on)} + t_r$) $V_{DD} = 30\text{ V}, V_{GS} = 5\text{ V}, I_D = 3\text{ A}, R_{GS} = 50\text{ }\Omega$	$t_{d(on)}$	–	25	40	ns
	t_r	–	75	120	
Turn-off time t_{off} , ($t_{off} = t_{d(off)} + t_f$) $V_{DD} = 30\text{ V}, V_{GS} = 5\text{ V}, I_D = 3\text{ A}, R_{GS} = 50\text{ }\Omega$	$t_{d(off)}$	–	110	160	
	t_f	–	75	95	

Electrical Characteristics (cont'd)

at $T_j = 25\text{ °C}$, unless otherwise specified.

Parameter	Symbol	Values			Unit
		min.	typ.	max.	

Reverse diode

Continuous reverse drain current $T_C = 25\text{ °C}$	I_S	–	–	25	A
Pulsed reverse drain current $T_C = 25\text{ °C}$	I_{SM}	–	–	100	
Diode forward on-voltage $I_S = 50\text{ A}$, $V_{GS} = 0\text{ V}$	V_{SD}	–	1.5	2.0	V
Reverse recovery time $V_R = 30\text{ V}$, $I_F = I_S$, $di_F / dt = 100\text{ A}/\mu\text{s}$	t_{rr}	–	60	–	ns
Reverse recovery charge $V_R = 30\text{ V}$, $I_F = I_S$, $di_F / dt = 100\text{ A}/\mu\text{s}$	Q_{rr}	–	0.1	–	μC

Characteristics at $T_j = 25^\circ\text{C}$, unless otherwise specified.

Total power dissipation

$$P_{\text{tot}} = f(T_C)$$

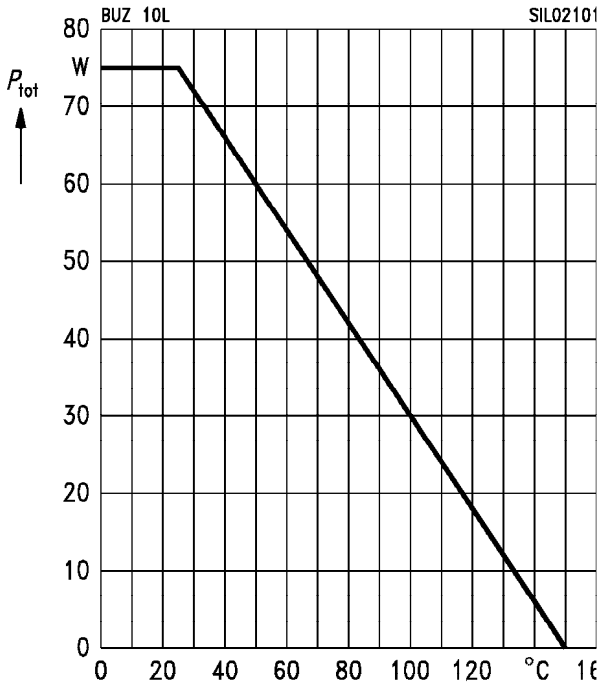

Typ. output characteristics

$$I_D = f(V_{DS})$$

parameter: $t_p = 80\ \mu\text{s}$

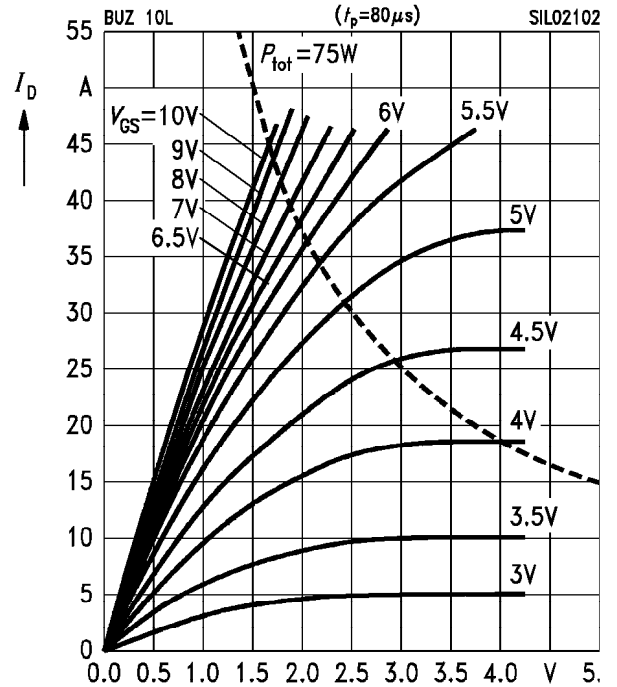

Safe operating area

$$I_D = f(V_{DS})$$

parameter: $D = 0.01$, $T_C = 25^\circ\text{C}$

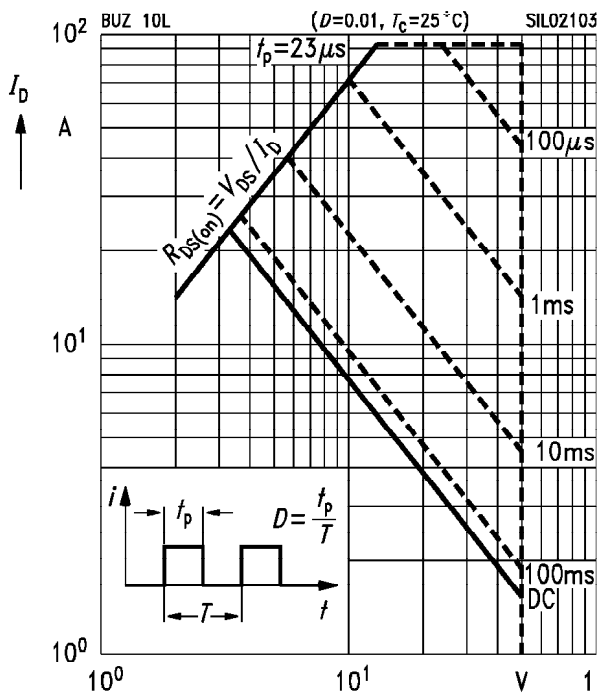

Typ. transfer characteristics

$$I_D = f(V_{GS})$$

parameter: $t_p = 80\ \mu\text{s}$, $V_{DS} = 25\text{V}$

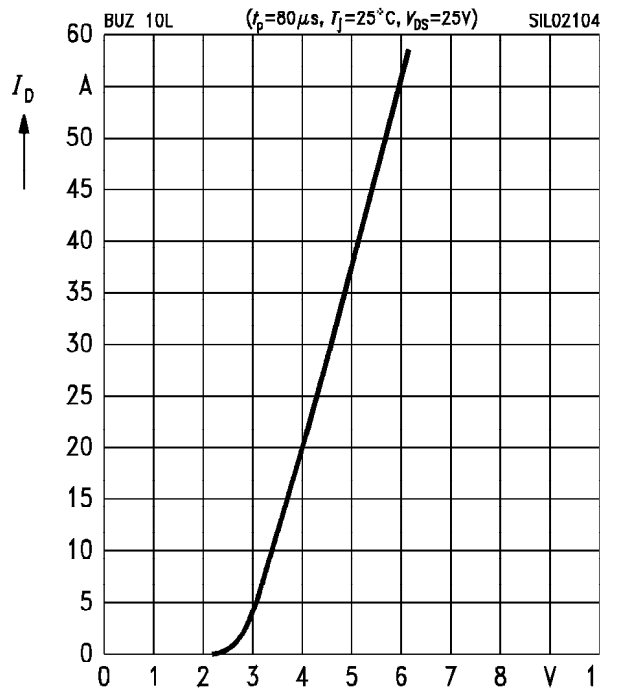

Typ. drain-source on-resistance

$R_{DS(on)} = f(I_D)$
parameter: V_{GS}

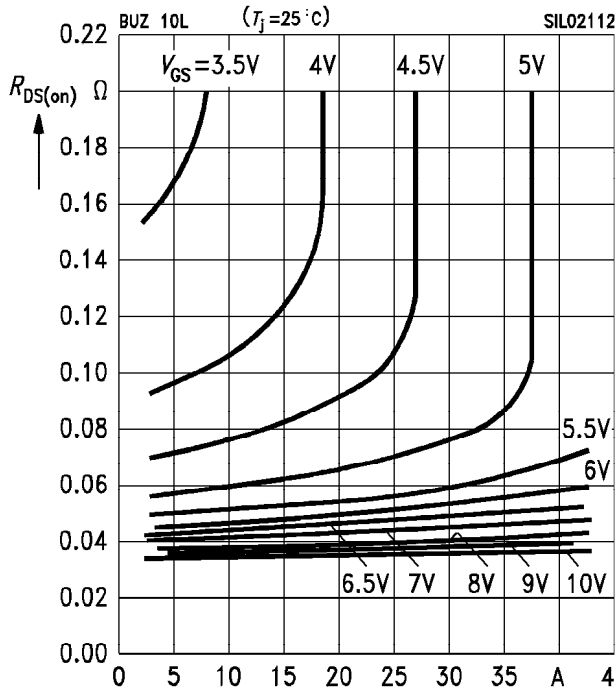

Drain-source on-resistance

$R_{DS(on)} = f(T_j)$
parameter: $I_D = 11.5\text{ A}$, $V_{GS} = 5\text{ V}$, (spread)

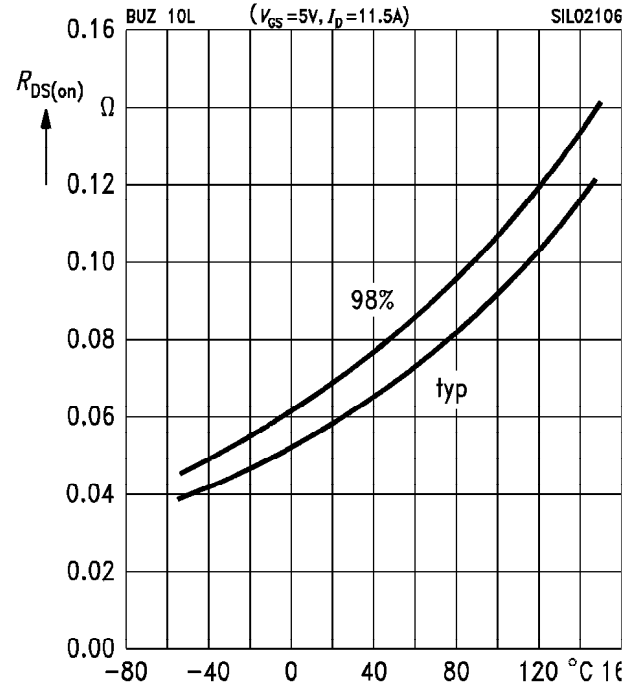

Typ. forward transconductance

$g_{fs} = f(I_D)$
parameter: $t_p = 80\ \mu\text{s}$

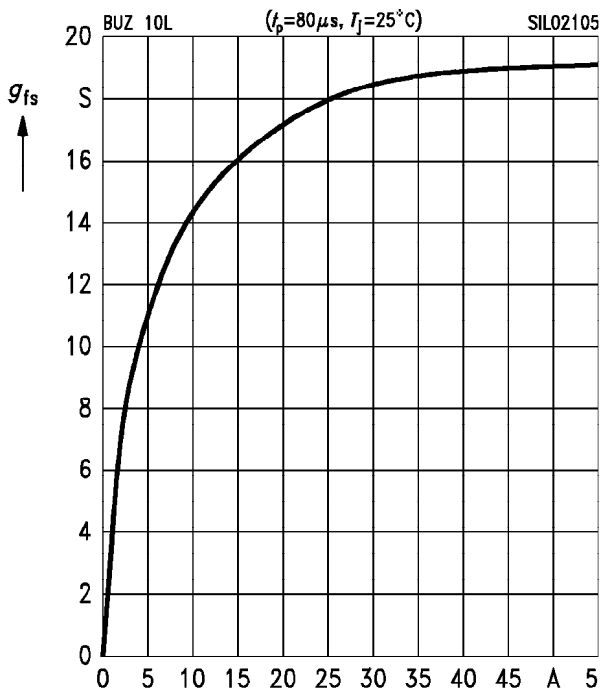

Gate threshold voltage

$V_{GS(th)} = f(T_j)$
parameter: $V_{GS} = V_{DS}$, $I_D = 1\text{ mA}$, (spread)

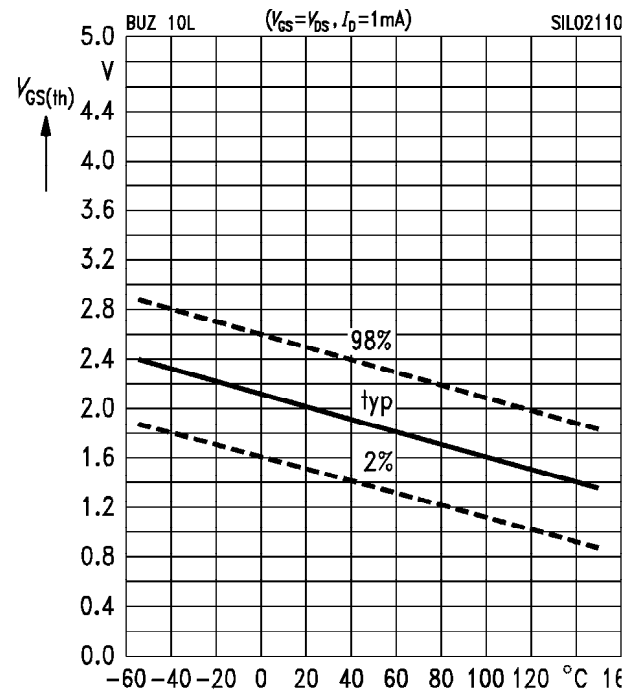

Typ. capacitances

$C = f(V_{DS})$

parameter: $V_{GS} = 0\text{ V}, f = 1\text{ MHz}$

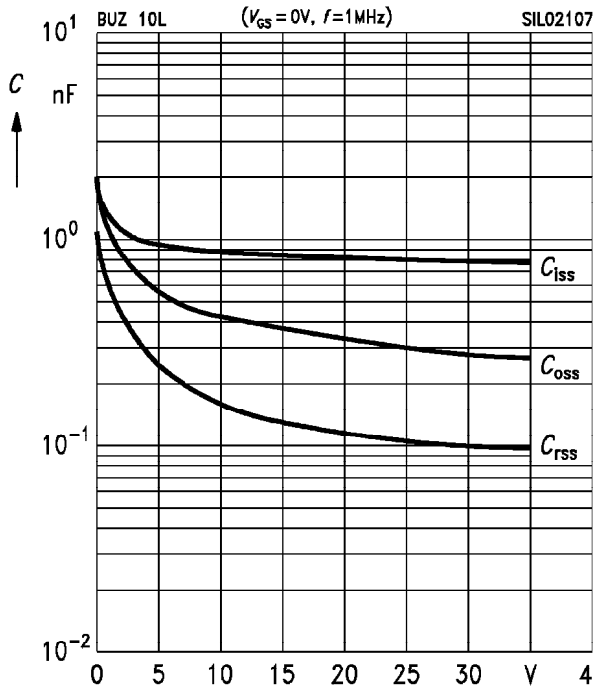

Drain current

$I_D = f(T_C)$

parameter: $V_{GS} \geq 5\text{ V}$

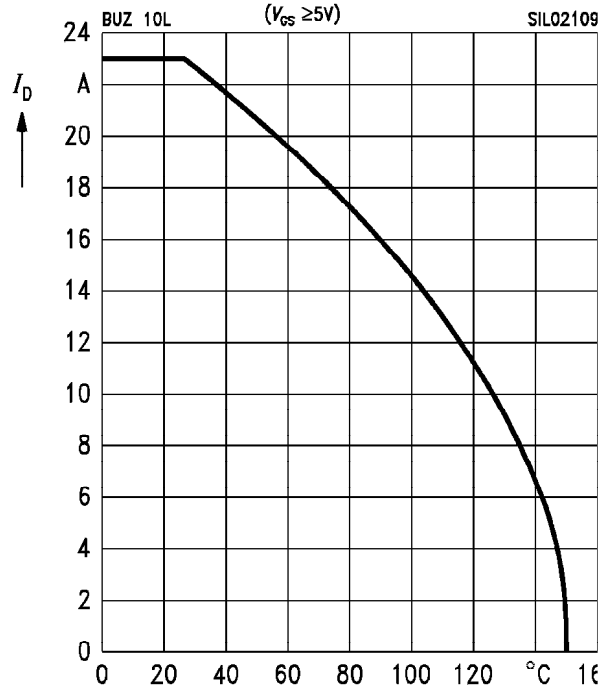

Forward characteristics of reverse diode

$I_F = f(V_{SD})$

parameter: $T_j, t_p = 80\ \mu\text{s}, (\text{spread})$

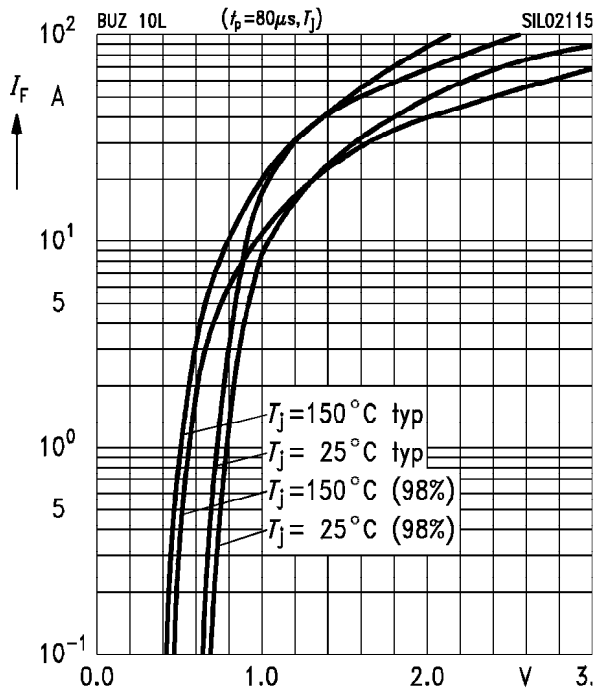

Avalanche energy E_{AS} = f(T_j)

parameter: $I_D = 23\text{ A}, V_{DD} = 25\text{ V}$

$R_{GS} = 25\ \Omega, L = 15.1\ \mu\text{H}$

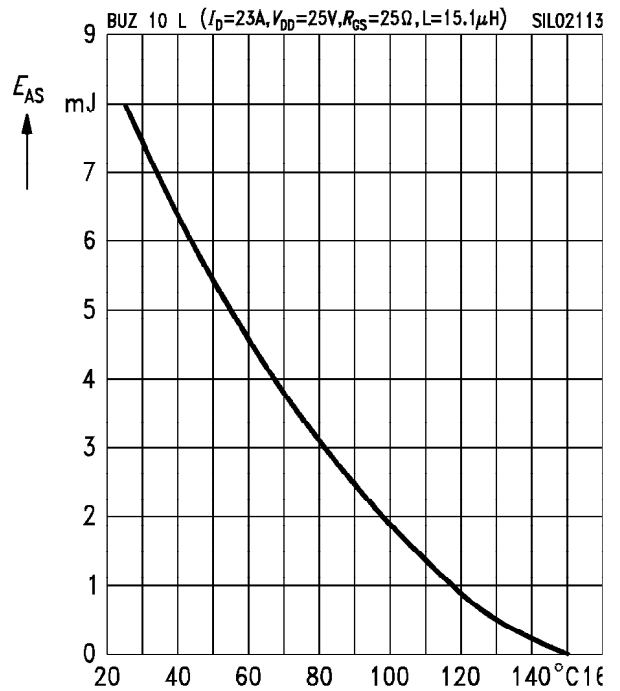

Transient thermal impedance

$Z_{thJC} = f(t_p)$

parameter: $D = t_p / T$

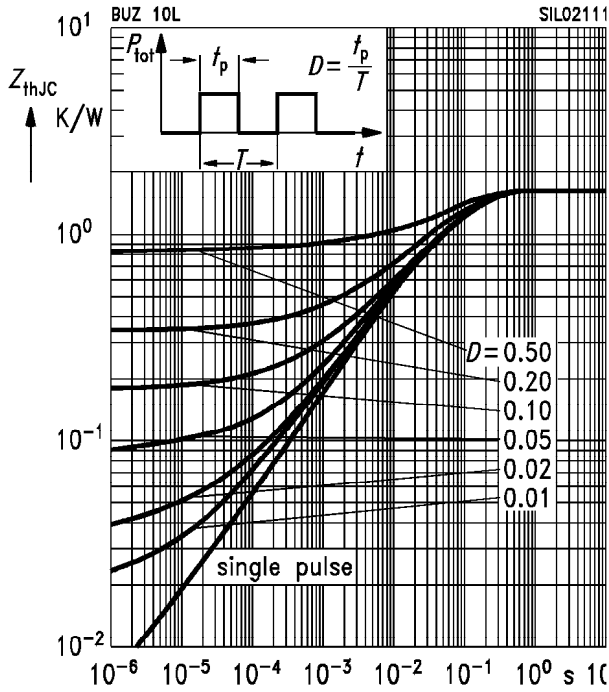

Typ. gate charge

$V_{GS} = f(Q_{Gate})$

parameter: $I_{Dpuls} = 37.5 A$

