

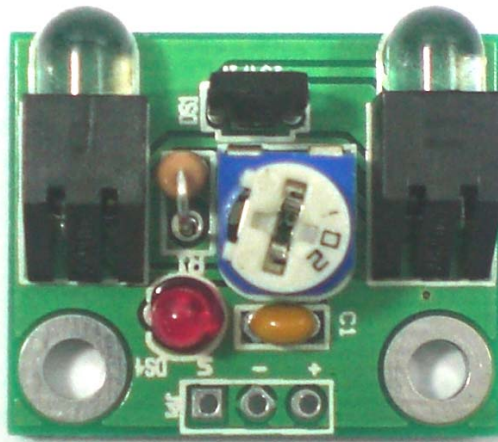

IR01A

Medium Range Infrared Sensor



User's Manual

V1.0

Sept 2008

Information contained in this publication regarding device applications and the like is intended through suggestion only and may be superseded by updates. It is your responsibility to ensure that your application meets with your specifications. No representation or warranty is given and no liability is assumed by Cytron Technologies Incorporated with respect to the accuracy or use of such information, or infringement of patents or other intellectual property rights arising from such use or otherwise. Use of Cytron Technologies's products as critical components in life support systems is not authorized except with express written approval by Cytron Technologies. No licenses are conveyed, implicitly or otherwise, under any intellectual property rights.

Index

1. Introduction and Overview	1
2. Packaging List	2
3. Product Specification and Limitations	3
4. Product Dimensions and Layout	4
5. Installation (hardware)	6
6. Getting Started	7
7. Warranty (3 months)	9

1. INTRODUCTION AND OVERVIEW

This Medium Range Infrared sensor offers simple, user friendly and fast obstacle detection using infrared; it is non contact detection. The implementations of modulated IR signal immune the sensor to the interferences caused by the normal light of a light bulb or the sun light. The sensing distance can be adjusted manually. The product features include:

- **5V powered**, low current consumption, **less than 10mA**.
- 3 pin interface which are **signal, GND** and **5V**.
- Small **LED as indicator** for detection status.
- Obstacle detection up to **10cm**.
- **Adjustable sensing range** (2cm – 10cm).
- Small size makes it easy to assembly.
- Single bit output.
- Compatible with all types of microcontrollers.

2. PACKAGING LIST

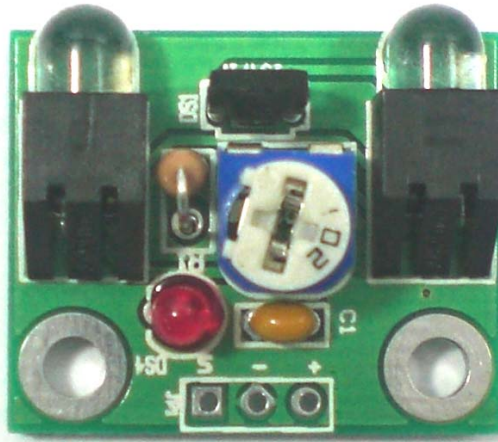

Please check the parts and components according to the packing list. If there are any parts missing, please contact us at sales@cytron.com.my immediately.

1. 1 x IR01A sensor module.

Note: No header or cable is provided with IR01A module to offer flexibility for user to solder any connector. Please obtain the necessary parts separately.

3. PRODUCT SPECIFICATION AND LIMITATIONS

3.1 Theory of Operation

IR01A uses special sensor to modulate IR signal emitted from 2 IR transmitters and detects the modulated IR signal reflected back from a nearby object. This sensor has a built-in IR LED driver to modulate the IR signal at 38KHz to match the built-in detector. The modulated IR signal immunizes the sensor from the interferences caused by the normal light of a light bulb or the sun light. The module will output a HIGH if no object is detected and a LOW if an object is detected.

3.2 Pin Definitions and Ratings

Pin	Name	Function
+	VCC	Connects to Vcc (+4V to + 6V)
-	Ground	Connects to Ground
s	Output signal	Connects to an I/O pin of microcontroller which set to INPUT mode (or transistor/MOSFET).

Table 3.1

3.3 Sensitivity

The Medium Range Infrared Sensor has a sensing range of approximately 2cm to 10cm. The sensitivity can vary with the reflectivity of the object and the ambient lighting. The modulated IR signal will reflect more on white surface and reflect less on black surface. The sensor is designed to adjustable sensing range. User may adjust sensing range by using the preset on IR01A for different application.

4. PRODUCT DIMENSIONS AND LAYOUT

4.1 Product Dimensions

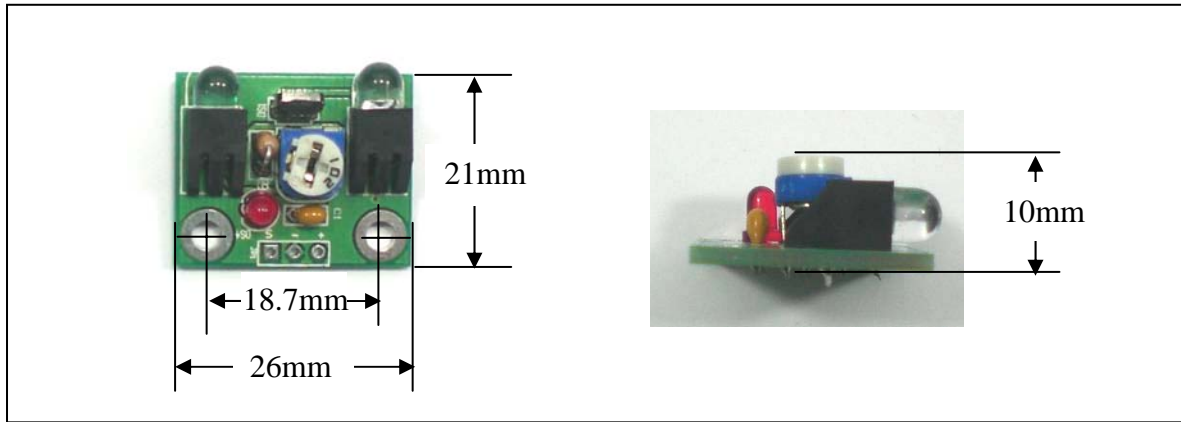

4.2 Product Layout

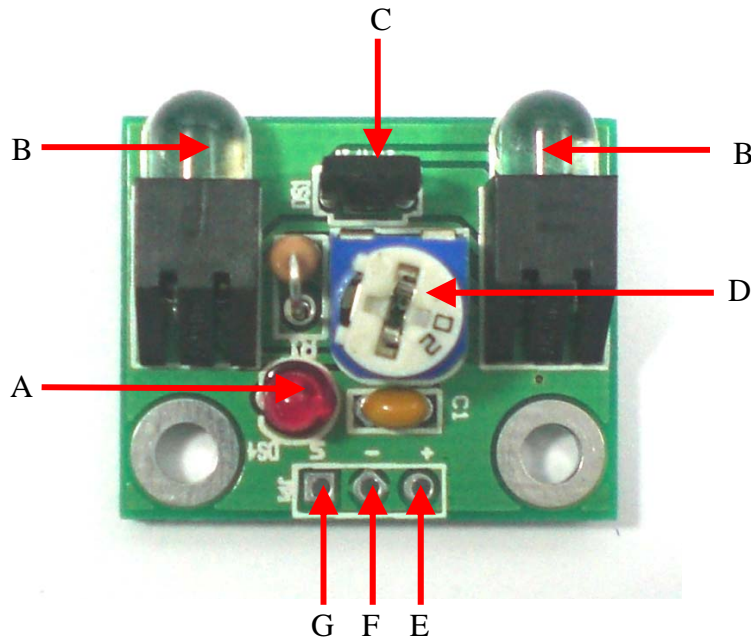

Label	Function	Label	Function
A	Signal indicator LED	E	The hole to solder and connect VCC (+).
B	IR transmitter	F	The hole to solder and connect GND (-)
C	IR sensor	G	The hole to solder and connect output signal (s)
D	Preset		

A – is a signal indicators LED for IR01A. The LED will turn ON when signal is detected on IR01A.

B – are 2 IR transmitters, the output IR signal is modulated at 38Khz.

C – is IR sensor. This sensor modulates IR signal emitted from 2 IR transmitters and detects the modulated IR signal reflected back from a nearby object.

D – is a 1K Ohm preset for user to adjust the sensing range. The sensing range is 2cm – 10cm. (Performance of the sensor will vary with the reflectivity of the object and the ambient lighting.)

E – is a hole to solder and connect the power supply to IR01A. User may supply 4V-6V to IR01A, the typical voltage is 5V.

F – is a hole to solder and connect Ground to IR01A. User may connect the GND(-) of IR01A to the Ground (0V) of the control board.

G – is a hole to solder and connect the output signal from IR01A. User may connect the signal pin(s) from IR01A to an I/O pin of microcontroller which set to INPUT mode. The output signal of IR01A is LOW or 0V when an object detected.

5. INSTALLATION (HARDWARE)

1) Connect 3x1 header pin to IR01A as shown below:



Figure 5.1

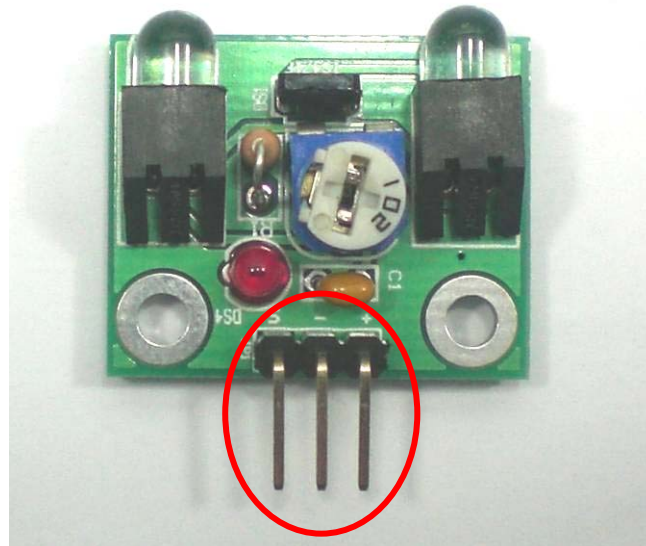

Figure 5.2

Note: User may also solder the cable to the soldering holes (+ - s) directly with depends on the application.

6. GETTING STARTED

Connect the 3-pin header to your circuit so that the VCC (+) pin connects to VCC (5V), the Ground (-) pin connects to ground (0V) and the output signal (s) pin connects to your microcontroller's I/O pin. One easy way to do this would be to use a standard 3 ways 2561 connector. The output signal is LOW whenever there is an object detected.

Please refer following steps for example application of IR01A together with IFC-DI08 (Interface Free Controller – Digital Input Card).

1. Connect IR01A to IFC-DI08 as shown in Figure:

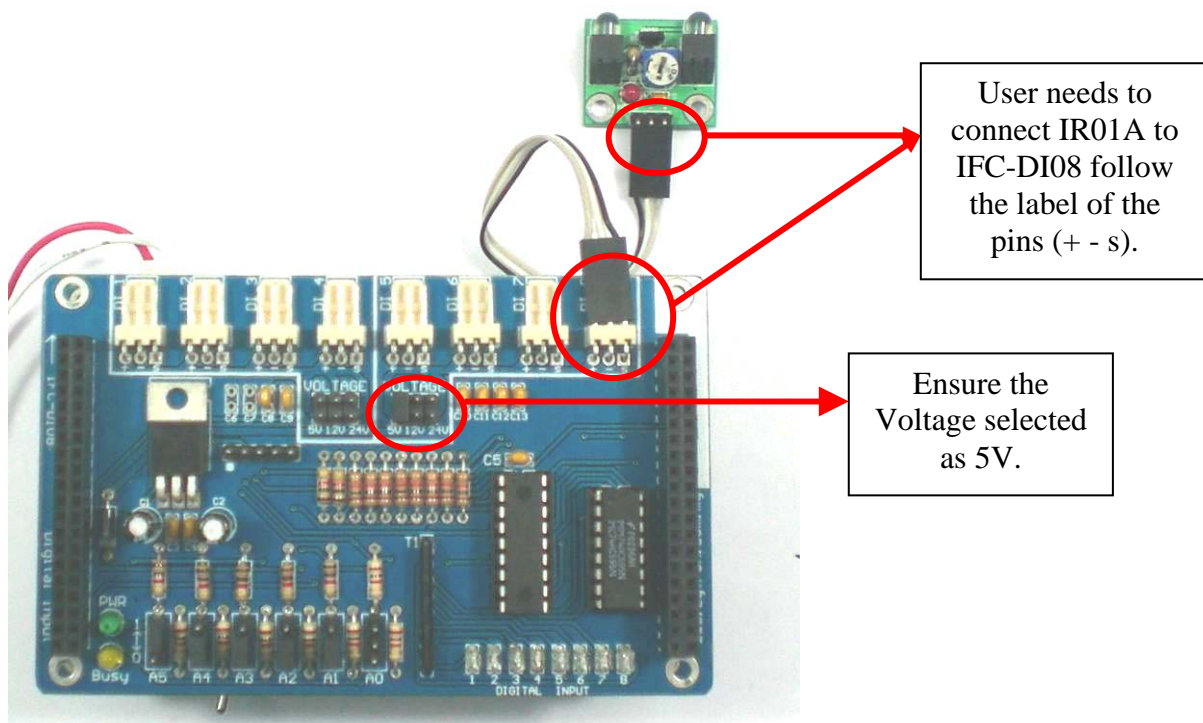

Figure 6.1

Note: Ensure the pins from IR01A are connected correctly to IFC-DI08. Wrong connection of IR01A will result improper function of IR01A and it might spoil the sensor module.

2. Switch ON IFC, and test the IR01A, the indicator LED on IR01A should turn ON when an object is proximity. User may adjust the sensing range by tuning the preset on IR01A. The sensing range is 2cm -10cm, the performance of the sensor will vary with the reflectivity of the object and the ambient lighting.

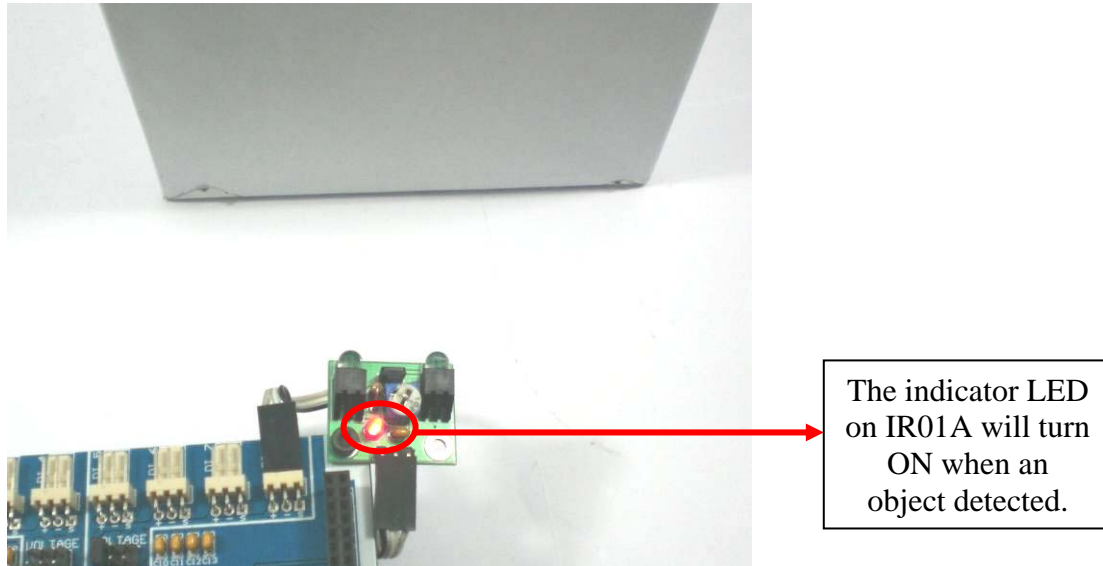

Figure 6.2

3. For the details description of IFC-DI08, user may refer to Cytron website:
<http://www.cytron.com.my/listProductCategory.asp?cid=285#3046>

Note: When tuning the sensing range, please ensure there is not leakage IR signal from the 2 IR transmitters. The indicator LED will always turn ON when there is leakage IR signal detected on IR sensor even there is not object nearby. User need to re-tuning the preset until there is not leakage IR signal from the module.

8. WARRANTY

- Product warranty is valid for 3 months.
- Warranty only applies to manufacturing defect.
- Damage caused by mis-use is not covered under warranty.
- Warranty does not cover freight cost for both ways.

Prepared by
Cytron Technologies Sdn. Bhd.
19, Jalan Kebudayaan 1A,
Taman Universiti,
81300 Skudai,
Johor, Malaysia.

Tel: +607-521 3178

Fax: +607-521 1861

URL: www.cytron.com.my

Email: support@cytron.com.my

sales@cytron.com.my