

Darlington 2SD1785

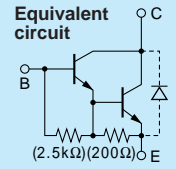

Silicon NPN Triple Diffused Planar Transistor (Complement to type 2SB1258)

Application : Driver for Solenoid, Relay and Motor, Series Regulator, and General Purpose

Absolute maximum ratings ($T_a=25^\circ\text{C}$)

Symbol	2SD1785	Unit
V_{CBO}	120	V
V_{CEO}	120	V
V_{EBO}	6	V
I_C	6(Pulse10)	A
I_B	1	A
P_C	30($T_c=25^\circ\text{C}$)	W
T_j	150	$^\circ\text{C}$
T_{stg}	-55 to +150	$^\circ\text{C}$

Electrical Characteristics ($T_a=25^\circ\text{C}$)

Symbol	Conditions	2SD1785	Unit
I_{CBO}	$V_{CB}=120\text{V}$	10max	μA
I_{EBO}	$V_{EB}=6\text{V}$	10max	mA
$V_{(BR)CEO}$	$I_C=10\text{mA}$	120min	V
h_{FE}	$V_{CE}=2\text{V}, I_C=3\text{A}$	2000min	
$V_{CE(sat)}$	$I_C=2\text{A}, I_B=3\text{mA}$	1.5max	V
f_T	$V_{CE}=12\text{V}, I_E=-0.1\text{A}$	100typ	MHz
COB	$V_{CB}=10\text{V}, f=1\text{MHz}$	70typ	pF

External Dimensions FM20(TO220F)

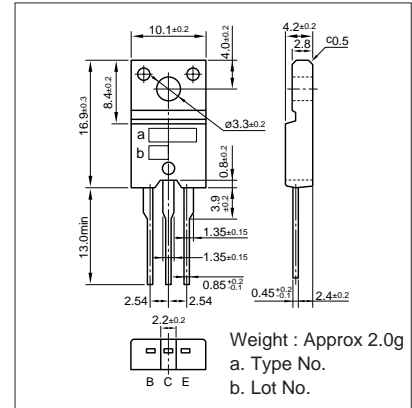

Typical Switching Characteristics (Common Emitter)

V_{CC} (V)	R_L (Ω)	I_C (A)	V_{BB1} (V)	V_{BB2} (V)	I_{B1} (mA)	I_{B2} (mA)	t_{on} (μs)	t_{stg} (μs)	t_f (μs)
30	10	3	10	-1.5	3	-3	0.5typ	5.5typ	1.5typ

I_C-V_{CE} Characteristics (Typical)

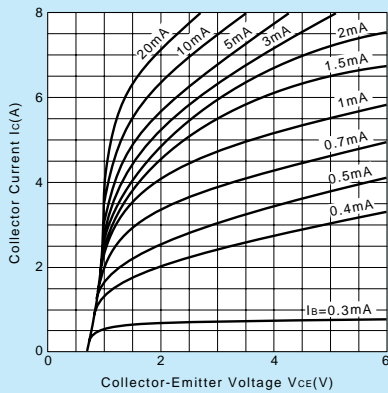

$V_{CE(sat)}-I_B$ Characteristics (Typical)

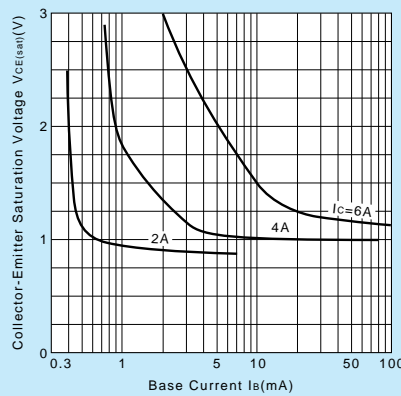

I_C-V_{BE} Temperature Characteristics (Typical)

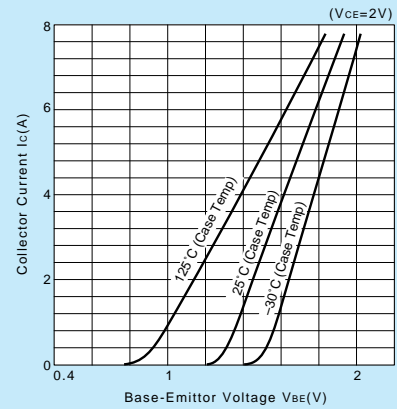

$h_{FE}-I_C$ Characteristics (Typical)

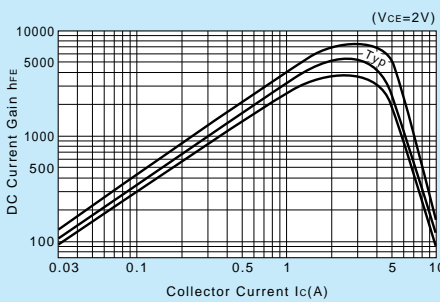

$h_{FE}-I_C$ Temperature Characteristics (Typical)

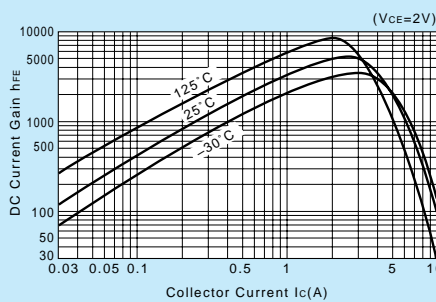

$\theta_{j-a}-t$ Characteristics

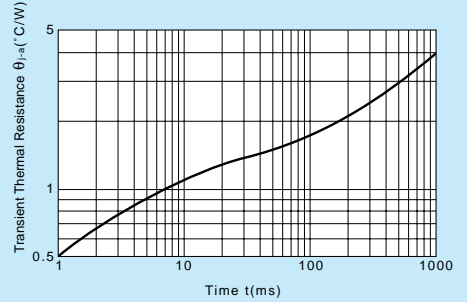

f_T-I_E Characteristics (Typical)

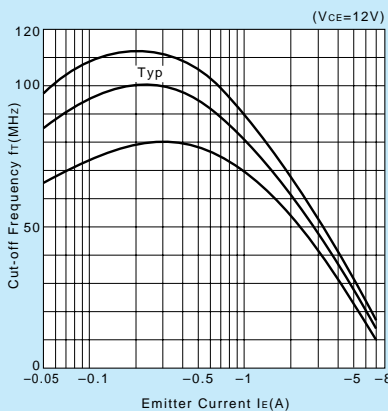

Safe Operating Area (Single Pulse)

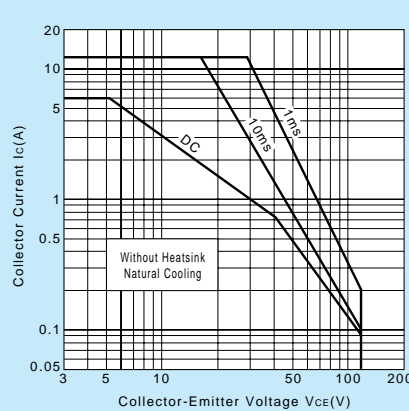

P_C-Ta Derating

