

DATA SHEET

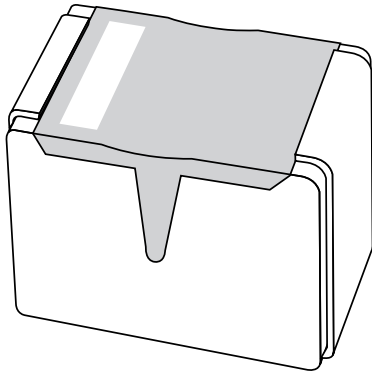

BZX284 series Voltage regulator diodes

Product specification
Supersedes data of December 1995
File under Discrete Semiconductors, SC01

1996 Apr 17

Voltage regulator diodes

BZX284 series

FEATURES

- Total power dissipation: max. 400 mW
- Two tolerance series: $\pm 2\%$ and $\pm 5\%$
- Working voltage range: nom. 2.4 to 75 V (E24 range).

DESCRIPTION

Low-power voltage regulator diodes in a small ceramic SMD SOD110 package. The diodes are available in the normalized E24 $\pm 2\%$ (BZX284-B) and $\pm 5\%$ (BZX284-C) tolerance range. The series consists of 37 types with nominal working voltages from 2.4 to 75 V.

APPLICATIONS

- General regulation functions.

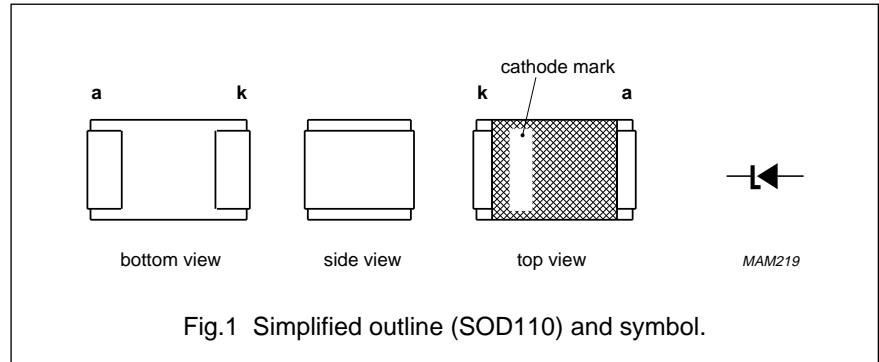

Fig.1 Simplified outline (SOD110) and symbol.

MARKING

TYPE NUMBER	MARKING CODE	TYPE NUMBER	MARKING CODE	TYPE NUMBER	MARKING CODE	TYPE NUMBER	MARKING CODE
BZX284-B2V4	WO	BZX284-B15	XH	BZX284-C2V4	YO	BZX284-C15	ZH
BZX284-B2V7	WP	BZX284-B16	XI	BZX284-C2V7	YP	BZX284-C16	ZI
BZX284-B3V0	WQ	BZX284-B18	XJ	BZX284-C3V0	YQ	BZX284-C18	ZJ
BZX284-B3V3	WR	BZX284-B20	XK	BZX284-C3V3	YR	BZX284-C20	ZK
BZX284-B3V6	WS	BZX284-B22	XL	BZX284-C3V6	YS	BZX284-C22	ZL
BZX284-B3V9	WT	BZX284-B24	XM	BZX284-C3V9	YT	BZX284-C24	ZM
BZX284-B4V3	WU	BZX284-B27	XN	BZX284-C4V3	YU	BZX284-C27	ZN
BZX284-B4V7	WV	BZX284-B30	XO	BZX284-C4V7	YV	BZX284-C30	ZO
BZX284-B5V1	WW	BZX284-B33	XP	BZX284-C5V1	YW	BZX284-C33	ZP
BZX284-B5V6	WX	BZX284-B36	XQ	BZX284-C5V6	YX	BZX284-C36	ZQ
BZX284-B6V2	WY	BZX284-B39	XR	BZX284-C6V2	YY	BZX284-C39	ZR
BZX284-B6V8	WZ	BZX284-B43	XS	BZX284-C6V8	YZ	BZX284-C43	ZS
BZX284-B7V5	XA	BZX284-B47	XT	BZX284-C7V5	ZA	BZX284-C47	ZT
BZX284-B8V2	XB	BZX284-B51	XU	BZX284-C8V2	ZB	BZX284-C51	ZU
BZX284-B9V1	XC	BZX284-B56	XV	BZX284-C9V1	ZC	BZX284-C56	ZV
BZX284-B10	XD	BZX284-B62	XW	BZX284-C10	ZD	BZX284-C62	ZW
BZX284-B11	XE	BZX284-B68	XX	BZX284-C11	ZE	BZX284-C68	ZX
BZX284-B12	XF	BZX284-B75	XY	BZX284-C12	ZF	BZX284-C75	ZY
BZX284-B13	XG	-	-	BZX284-C13	ZG	-	-

Voltage regulator diodes

BZX284 series

LIMITING VALUES

In accordance with the Absolute Maximum Rating System (IEC 134).

SYMBOL	PARAMETER	CONDITIONS	MIN.	MAX.	UNIT
I_F	continuous forward current		–	250	mA
I_{ZSM}	non-repetitive peak reverse current	$t_p = 100 \mu\text{s}$; square wave; $T_{\text{amb}} = 25 \text{ }^\circ\text{C}$ prior to surge	see Tables 1 and 2		
P_{tot}	total power dissipation	$T_{\text{amb}} = 25 \text{ }^\circ\text{C}$; note 1	–	400	mW
T_{stg}	storage temperature		–65	+150	$^\circ\text{C}$
T_j	junction temperature		–	150	$^\circ\text{C}$

Note

1. Device mounted on a printed-circuit board: $11 \times 25 \times 1.6 \text{ mm}$.

ELECTRICAL CHARACTERISTICS**Total BZX284-B and C series** $T_j = 25 \text{ }^\circ\text{C}$ unless otherwise specified.

SYMBOL	PARAMETER	CONDITIONS	MAX.	UNIT
V_F	forward voltage	$I_F = 10 \text{ mA}$; see Fig.4	0.9	V
		$I_F = 100 \text{ mA}$; see Fig.4	1.1	V
I_R	reverse current			
	BZX284-B/C2V4	$V_R = 1 \text{ V}$	50	μA
	BZX284-B/C2V7	$V_R = 1 \text{ V}$	20	μA
	BZX284-B/C3V0	$V_R = 1 \text{ V}$	10	μA
	BZX284-B/C3V3	$V_R = 1 \text{ V}$	5	μA
	BZX284-B/C3V6	$V_R = 1 \text{ V}$	5	μA
	BZX284-B/C3V9	$V_R = 1 \text{ V}$	3	μA
	BZX284-B/C4V3	$V_R = 1 \text{ V}$	3	μA
	BZX284-B/C4V7	$V_R = 2 \text{ V}$	3	μA
	BZX284-B/C5V1	$V_R = 2 \text{ V}$	2	μA
	BZX284-B/C5V6	$V_R = 2 \text{ V}$	1	μA
	BZX284-B/C6V2	$V_R = 4 \text{ V}$	3	μA
	BZX284-B/C6V8	$V_R = 4 \text{ V}$	2	μA
	BZX284-B/C7V5	$V_R = 5 \text{ V}$	1	μA
	BZX284-B/C8V2	$V_R = 5 \text{ V}$	700	nA
	BZX284-B/C9V1	$V_R = 6 \text{ V}$	500	nA
	BZX284-B/C10	$V_R = 7 \text{ V}$	200	nA
	BZX284-B/C11	$V_R = 8 \text{ V}$	100	nA
BZX284-B/C12	$V_R = 8 \text{ V}$	100	nA	
BZX284-B/C13	$V_R = 8 \text{ V}$	100	nA	
BZX284-B/C15 to 75	$V_R = 0.7V_{Z\text{nom}}$	50	nA	

Voltage regulator diodes

BZX284 series

Table 1 Per type BZX284-B/C2V4 to B/C24
 T_j = 25 °C unless otherwise specified.

BZX284- B or C XXX	WORKING VOLTAGE V _Z (V) at I _{Ztest} = 5 mA			DIFFERENTIAL RESISTANCE r _{diff} (Ω)						TEMP. COEFF. S _Z (mV/K) at I _{Ztest} = 5 mA (see Figs 5 and 6)	DIODE CAP. C _d (pF) at f = 1 MHz; V _R = 0 V	NON-REPETITIVE PEAK REVERSE CURRENT I _{ZSM} (A) at t _p = 100 μs; T _{amb} = 25 °C
	Tot. ±2% (B)		Tol. ±5% (C)	at I _{Ztest} = 1 mA		at I _{Ztest} = 5 mA		TYP.	MAX.			
	MIN.	MAX.	MIN.	MAX.	TYP.	MAX.						
2V4	2.35	2.45	2.2	2.6	275	400	70	100	-1.6	450	12.0	
2V7	2.65	2.75	2.5	2.9	300	450	75	100	-2.0	440	12.0	
3V0	2.94	3.06	2.8	3.2	325	500	80	95	-2.1	425	12.0	
3V3	3.23	3.37	3.1	3.5	350	500	85	95	-2.4	410	12.0	
3V6	3.53	3.67	3.4	3.8	375	500	85	90	-2.4	390	12.0	
3V9	3.82	3.98	3.7	4.1	400	500	85	90	-2.5	370	12.0	
4V3	4.21	4.39	4.0	4.6	410	600	80	90	-2.5	350	12.0	
4V7	4.61	4.79	4.4	5.0	425	500	50	80	-1.4	325	12.0	
5V1	5.00	5.20	4.8	5.4	400	480	40	60	-0.8	300	12.0	
5V6	5.49	5.71	5.2	6.0	80	400	15	40	1.2	275	12.0	
6V2	6.08	6.32	5.8	6.6	40	150	6	10	2.3	250	12.0	
6V8	6.66	6.94	6.4	7.2	30	80	6	15	3.0	215	12.0	
7V5	7.35	7.65	7.0	7.9	15	80	2	10	4.0	170	4.0	
8V2	8.04	8.36	7.7	8.7	20	80	2	10	4.6	150	4.0	
9V1	8.92	9.28	8.5	9.6	20	100	2	10	5.5	120	3.0	
10	9.80	10.20	9.4	10.6	20	150	2	10	6.4	110	3.0	
11	10.80	11.20	10.4	11.6	25	150	2	10	7.4	108	2.5	
12	11.80	12.20	11.4	12.7	25	150	2	10	8.4	105	2.5	
13	12.70	13.30	12.4	14.1	25	170	2	10	9.4	103	2.5	
15	14.70	15.30	13.8	15.6	25	200	3	15	11.4	99	2.0	
16	15.70	16.30	15.3	17.1	25	200	4	20	12.4	97	1.5	
18	17.60	18.40	16.8	19.1	25	225	4	20	14.4	93	1.5	
20	19.60	20.40	18.8	21.2	30	225	4	20	16.4	88	1.5	
22	21.60	22.40	20.8	23.3	30	250	5	25	18.4	84	1.25	
24	23.50	24.50	22.8	25.6	30	250	6	30	20.4	80	1.25	

Voltage regulator diodes

BZX284 series

Table 2 Per type BZX284-B/C27 to B/C75
 $T_j = 25\text{ }^\circ\text{C}$ unless otherwise specified.

BZX284-B or C XXX	WORKING VOLTAGE V_Z (V) at $I_{Ztest} = 2\text{ mA}$			DIFFERENTIAL RESISTANCE r_{diff} (Ω)						TEMP. COEFF. S_Z (mV/K) at $I_{Ztest} = 2\text{ mA}$	DIODE CAP. C_d (pF) at $f = 1\text{ MHz}$; $V_R = 0\text{ V}$	NON-REPETITIVE PEAK REVERSE CURRENT I_{ZSM} (A) at $t_p = 100\text{ }\mu\text{s}$; $T_{amb} = 25\text{ }^\circ\text{C}$
	Tol. $\pm 2\%$ (B)			at $I_{Ztest} = 0.5\text{ mA}$		at $I_{Ztest} = 2\text{ mA}$						
	MIN.	MAX.	Tol. $\pm 5\%$ (C)	TYP.	MAX.	TYP.	MAX.					
27	26.50	27.50	25.1	28.9	35	250	8	40	23.4	73	1.0	
30	29.40	30.60	28.0	32.0	35	250	10	40	26.6	66	1.0	
33	32.30	33.70	31.0	35.0	40	275	11	40	29.7	60	0.9	
36	35.30	36.70	34.0	38.0	40	300	15	60	33.0	59	0.8	
39	38.20	39.80	37.0	41.0	40	300	25	75	36.4	58	0.7	
43	42.10	43.90	40.0	46.0	45	325	30	80	41.2	56	0.6	
47	46.10	47.90	44.0	50.0	45	325	30	90	46.1	55	0.5	
51	50.00	52.00	48.0	54.0	45	350	35	110	51.0	52	0.4	
56	54.90	57.10	52.0	60.0	50	375	40	120	57.0	49	0.3	
62	60.80	63.20	58.0	66.0	60	400	50	140	64.4	44	0.3	
68	66.60	69.40	64.0	72.0	75	400	55	160	71.7	40	0.25	
75	73.50	76.50	70.0	79.0	85	400	70	175	80.2	35	0.2	

Voltage regulator diodes

BZX284 series

THERMAL CHARACTERISTICS

SYMBOL	PARAMETER	CONDITIONS	VALUE	UNIT
$R_{th\ j-a}$	thermal resistance from junction to ambient	note 1	315	K/W

Note

1. Device mounted on a printed-circuit board: $11 \times 25 \times 1.6$ mm.

MOUNTING

Reflow soldering

Follow standard reflow soldering techniques to ensure correct application of solder paste and placement of the SOD110 package (see Fig.2).

Wave soldering

Before wave soldering, attach SOD110 packages to the printed-circuit boards using a small dot of thermo-setting epoxy or UV-curing adhesive centred between the soldering lands (see Fig.3).

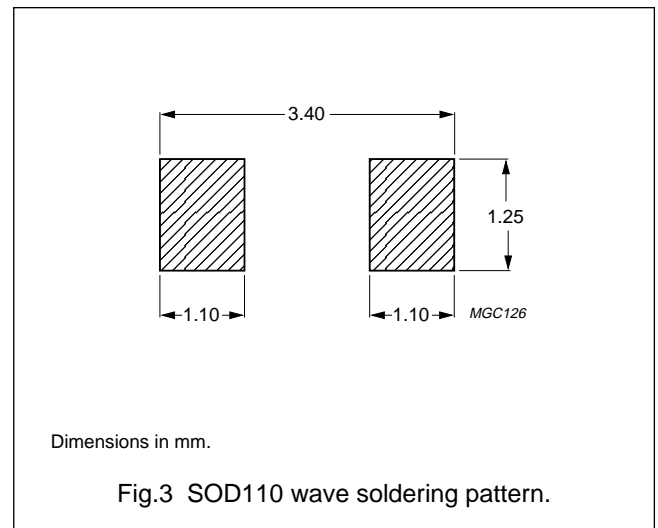
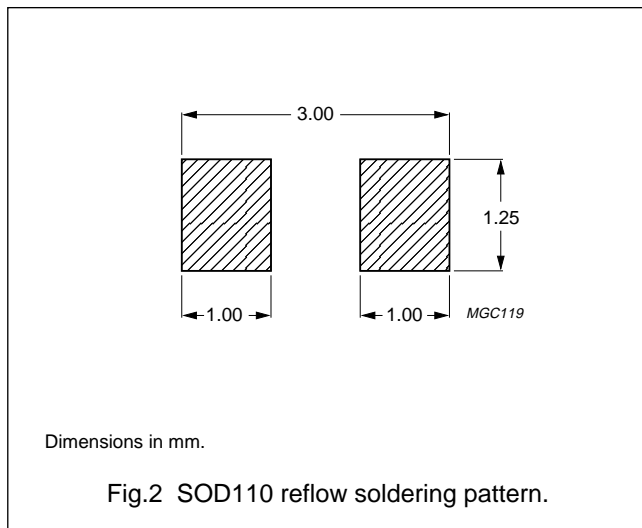

Voltage regulator diodes

BZX284 series

GRAPHICAL DATA

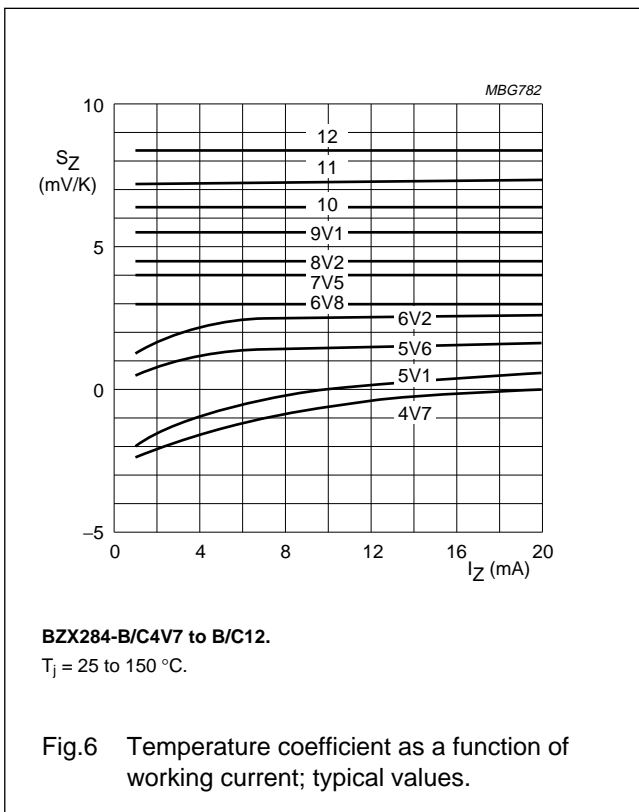
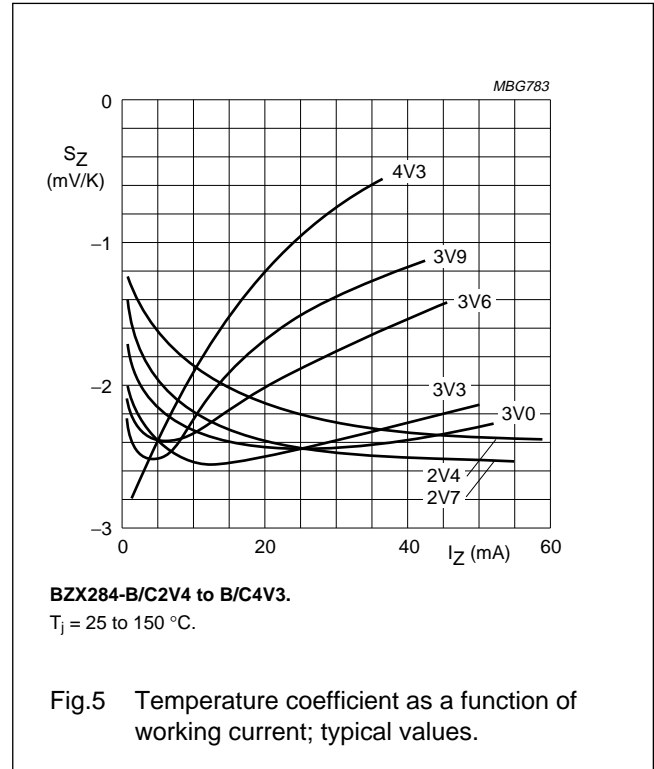
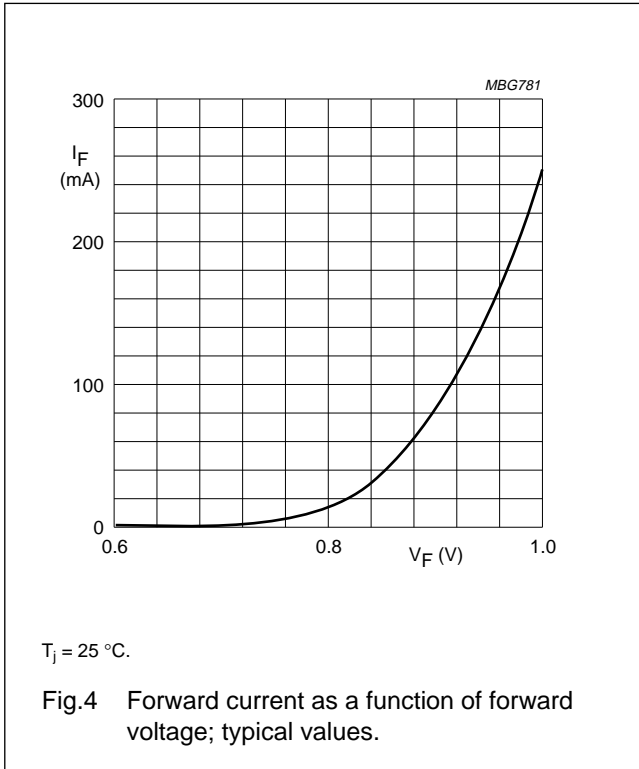

Voltage regulator diodes

BZX284 series

PACKAGE OUTLINE

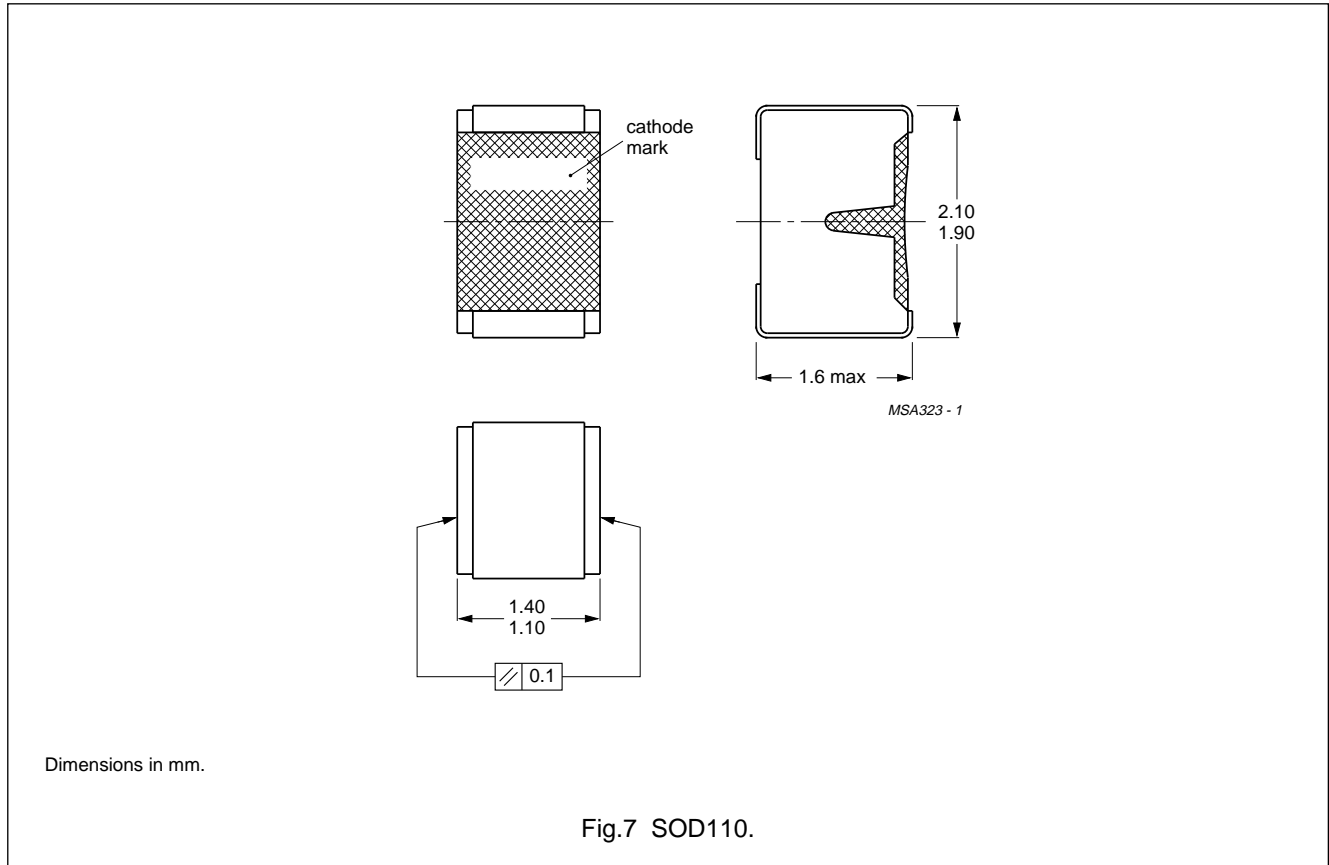

DEFINITIONS

Data sheet status	
Objective specification	This data sheet contains target or goal specifications for product development.
Preliminary specification	This data sheet contains preliminary data; supplementary data may be published later.
Product specification	This data sheet contains final product specifications.
Limiting values	
Limiting values given are in accordance with the Absolute Maximum Rating System (IEC 134). Stress above one or more of the limiting values may cause permanent damage to the device. These are stress ratings only and operation of the device at these or at any other conditions above those given in the Characteristics sections of the specification is not implied. Exposure to limiting values for extended periods may affect device reliability.	
Application information	
Where application information is given, it is advisory and does not form part of the specification.	

LIFE SUPPORT APPLICATIONS

These products are not designed for use in life support appliances, devices, or systems where malfunction of these products can reasonably be expected to result in personal injury. Philips customers using or selling these products for use in such applications do so at their own risk and agree to fully indemnify Philips for any damages resulting from such improper use or sale.